

CONSOLIDATION OF GEOLOGIC STUDIES  
OF GEOPRESSURED-GEOTHERMAL RESOURCES  
IN TEXAS: BARRIER-BAR TIDAL-CHANNEL  
RESERVOIR FACIES ARCHITECTURE, JACKSON GROUP,  
PRADO FIELD, SOUTH TEXAS

Final Report

by Steven J. Seni and Suk Joo Choh

Prepared for the U.S. Department of Energy  
Advanced Technologies Division  
under Cooperative Agreement No. DE-FC07-85NV10412

Bureau of Economic Geology  
W. L. Fisher, Director  
The University of Texas at Austin  
Austin, Texas 78713-7508

September 1993

## CONTENTS

ABSTRACT .....	1
INTRODUCTION.....	1
PRADO FIELD.....	3
Production History.....	7
GEOLOGIC CHARACTERIZATION .....	10
Structure.....	12
Depositional Framework.....	16
Sand-Body Architecture and Depositional Facies .....	20
Reservoir Models .....	28
Log Facies.....	30
Unsegmented Barrier-Bar Reservoir Model.....	35
Tidal Channel-Inlet Fill Reservoir Model .....	40
DISCUSSION.....	41
CONCLUSIONS.....	42
ACKNOWLEDGMENTS.....	43
REFERENCES.....	45

### Figures

1. Outline of Jackson-Yegua barrier/strandplain play, South Texas.....	4
2. Typical log from Prado field.....	5
3. Production history of Prado field.....	8
4. Map showing initial potential reported for wells in Prado field.....	9
5. Well control and general structural configuration around Prado field .....	11
6. Structure-contour maps, Prado field .....	13

7. Stratigraphic dip-oriented cross section, Prado field area.....	14
8. Structure-contour map of top Middle Loma Novia II sandstone.....	15
9. Structural cross section showing structural crest over sand-rich Middle Loma Novia interval ...	17
10. Net-sandstone map of lower Jackson Group and distribution of major Jackson oil reservoirs.....	19
11. Strike-oriented cross section, Prado field .....	22
12. Dip-oriented cross section, Prado field.....	23
13. Percentage-sandstone maps, Prado field.....	24
14. Map of axis of maximum sandstone accumulation and updip and downdip lines marking sandstone pinch-outs.....	26
15. Component depositional facies of barrier-bar sand body .....	29
16. SP log facies, Prado field.....	31
17. Detailed electric log and lithologic description of reservoir interval.....	33
18. Depositional facies, Prado field.....	36
19. Structural cross section, Prado field.....	39

#### Table

1. Engineering characteristics, Prado field.....	6
--	---

#### Appendices

1. Well log list.....	47
2. Cross section well list.....	53

## ABSTRACT

Sandstone reservoirs in the Jackson barrier/strandplain play are characterized by low recovery efficiencies and thus contain a large hydrocarbon resource target potentially amenable to advanced recovery techniques. Prado field, Jim Hogg County, South Texas, has produced over 23 million bbl of oil and over 32 million mcf gas from combination structural-stratigraphic traps in the Eocene lower Jackson Group. Hydrocarbon entrapment at Prado field is a result of anticlinal noseing by differential compaction and updip pinch-out of barrier bar sandstone. Relative base-level lowering resulted in forced regression that established lower Jackson shoreline sandstones in a relatively distal location in central Jim Hogg County. Reservoir sand bodies at Prado field comprise complex assemblages of barrier-bar, tidal-inlet fill, back-barrier bar, and shoreface environments. Subsequent progradation built the barrier-bar system seaward 1 to 2 mi. Within the barrier-bar system, favorable targets for hydrocarbon reexploration are concentrated in tidal-inlet facies because they possess the greatest degree of depositional heterogeneity.

## INTRODUCTION

Barrier/strandplain depositional systems host important hydrocarbon reservoirs in Tertiary strata of the Texas Gulf Coast Plain (Galloway and others, 1983). Major hydrocarbon plays are associated with the following barrier/strandplain depositional systems: Miocene (Galloway and others, 1986), Oligocene Frio Formation (Galloway and others, 1982; Galloway and Cheng, 1985), and Eocene Jackson Group (Fisher and others, 1970). Fields in the Frio Formation Greta-Carancahua barrier/strandplain system have undergone modern, detailed reservoir studies (Galloway and Cheng, 1985; Tyler and Ambrose, 1985), in part reflecting that system's tremendous hydrocarbon endowment. Galloway and others (1983) estimate that reservoirs greater than 10 million bbl in the Frio barrier/strandplain play contain 4.2 billion bbl of oil in place. Recovery efficiency for the large reservoirs in Frio barrier/strandplain plays is a relatively high 54 percent (weighted average of Frio barrier/strandplain plays; Galloway and others, 1983). Large reservoirs in the Eocene Jackson Group South Texas barrier/strandplain play contain an estimated

1.2 billion bbl of oil in place (Galloway and others, 1983) and have produced 431 million bbl of oil (through 1/1/92). However, Jackson Group reservoirs have an average recovery efficiency of only 38 percent (Galloway and others, 1983).

Barrier/strandplain reservoirs of the Jackson Group of South Texas are characterized by stratigraphic entrapment of oil at shallow burial depth. Recovery efficiencies for the play are relatively low despite high porosity and permeability typical of barrier/strandplain deposits. The low recovery efficiencies are presumed to result from low API gravities, weak solution drive, and reservoir heterogeneities. Tyler and Ambrose (1985) cite the preferential stratigraphic entrapment of oil in thin back-barrier reservoirs as contributing to poor recovery efficiency from the Jackson Group. Secondary recovery waterflood techniques typically are used to assist the weak solution drive. Many reservoirs have undergone tertiary recovery techniques including steam stimulation, fire floods, and miscible floods. Another advanced recovery technique—geothermal water flood—has been proposed as a potential method for improving recovery efficiency (Seni and Walter, in press). The low recovery efficiency of Jackson Group barrier/strandplain reservoirs indicates that a substantial resource target for enhanced oil recovery exists in known reservoirs at relatively shallow depth. Thus, Jackson Group reservoirs are appropriate for detailed reservoir studies because of the large remaining oil resource target and because they have not received the detailed reservoir characterization that has been afforded the Frio Formation.

Prado field in Jim Hogg County was selected for detailed reservoir characterization as a typical example of a large multireservoir field in the Jackson Group barrier/strandplain system of South Texas. Both secondary and advanced tertiary recovery operations are predicated on a thorough understanding of reservoir architecture. Evaluation of the potential for field reexploration and for increasing oil recovery in Texas requires detailed field examples of selected reservoirs. Prado field is suited for such an appraisal owing to the abundance of subsurface well data and the commitment of the current field operator to field reexploration.

The purpose of this report is (1) to describe and analyze the sand-body architecture, depositional facies variations, and structure of Prado field, (2) to determine controls on distribution of hydrocarbons pertinent to reexploration for bypassed hydrocarbons, (3) to describe reservoir models at Prado field, and

(4) to develop new data affecting the suitability of Jackson oil fields as possible candidates for thermally enhanced recovery of medium to heavy oil.

## PRADO FIELD

Prado field in Jim Hogg County, South Texas, produces oil and gas from the downdip margin of Jackson Group barrier/strandplain play (fig. 1). Most Jackson fields were discovered in the 1920's and 1930's. Prado field was discovered in 1956, late in the exploration history of the Jackson Group (West, 1963). Prado has produced over 23 million bbl of oil and is currently undergoing reexploration following an extended period of steeply declining production. Primary targets are bypassed hydrocarbons in small untapped compartments isolated by stratigraphic heterogeneities. Reservoir sandstones in Prado field produce hydrocarbons from combination stratigraphic/structural traps in narrow, strike-elongate sandstones that are encased in shale. Sand bodies extend subregionally and are locally designated from top to bottom as the Upper Government Wells, Middle Government Wells, Lower Government Wells, Upper Loma Novia, Middle Loma Novia, and Prado (fig. 2, Prado S. K. East No. 54). Stratigraphic entrapment is a result of updip pinch-out of barrier-bar, back-barrier, and tidal-channel sandstones. The more subtle structural component is a result of differential compaction. Although the initial field discovery was in the Prado sand, the Middle Loma Novia is the primary producer and is divided into a series of discrete reservoirs (LN I, LN II, LN III) that have uncertain reservoir compartmentalization and gas/oil/water contacts.

Geologic and engineering characteristics of Prado field are listed in table 1. Approximately 68.9 million bbl of oil is estimated to have originally been in place in Middle Loma Novia reservoirs. Cumulative oil production of 23 million bbl yields a recovery efficiency of 34 percent. Reservoir production energy is derived predominantly from solution gas drive and gas cap expansion. Relatively rapid downdip and updip pinch-out of reservoir sandstones limits water drive because of the small size of the available aquifer. Average porosity from the primary Middle Loma Novia reservoirs is 32 percent and average permeability is 901 md. The Middle Loma Novia and Prado reservoirs are complex

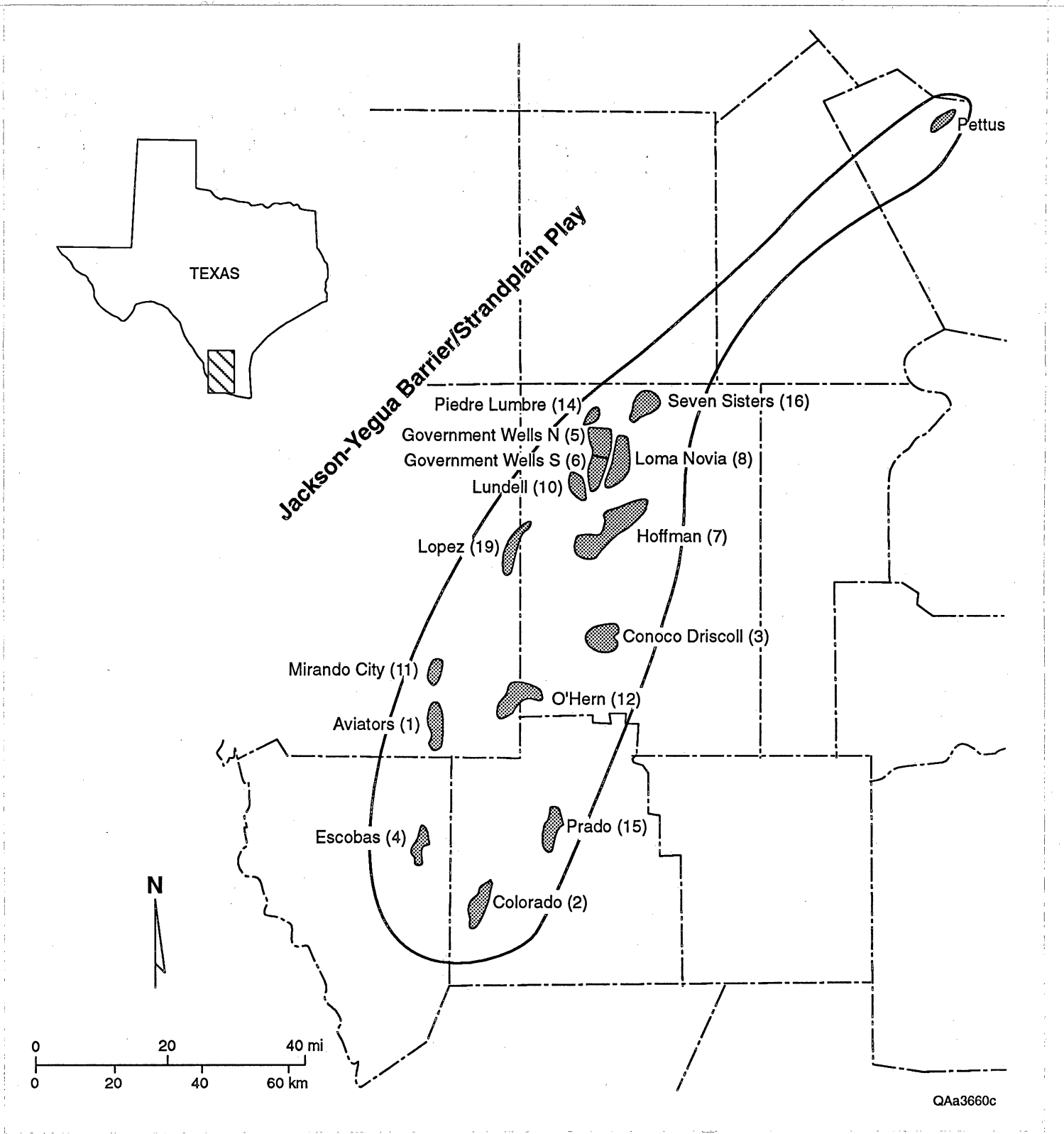


Figure 1. Outline of Jackson-Yegua barrier/strandplain play, South Texas. Only fields with reservoirs that have cumulative production greater than 10 million bbl are shown. Numbers next to field names refer to specific fields shown in figure 10. Modified from Galloway and others (1983).

PRADO OIL AND GAS  
 S.K. East No. 54  
 Well ID No. 101

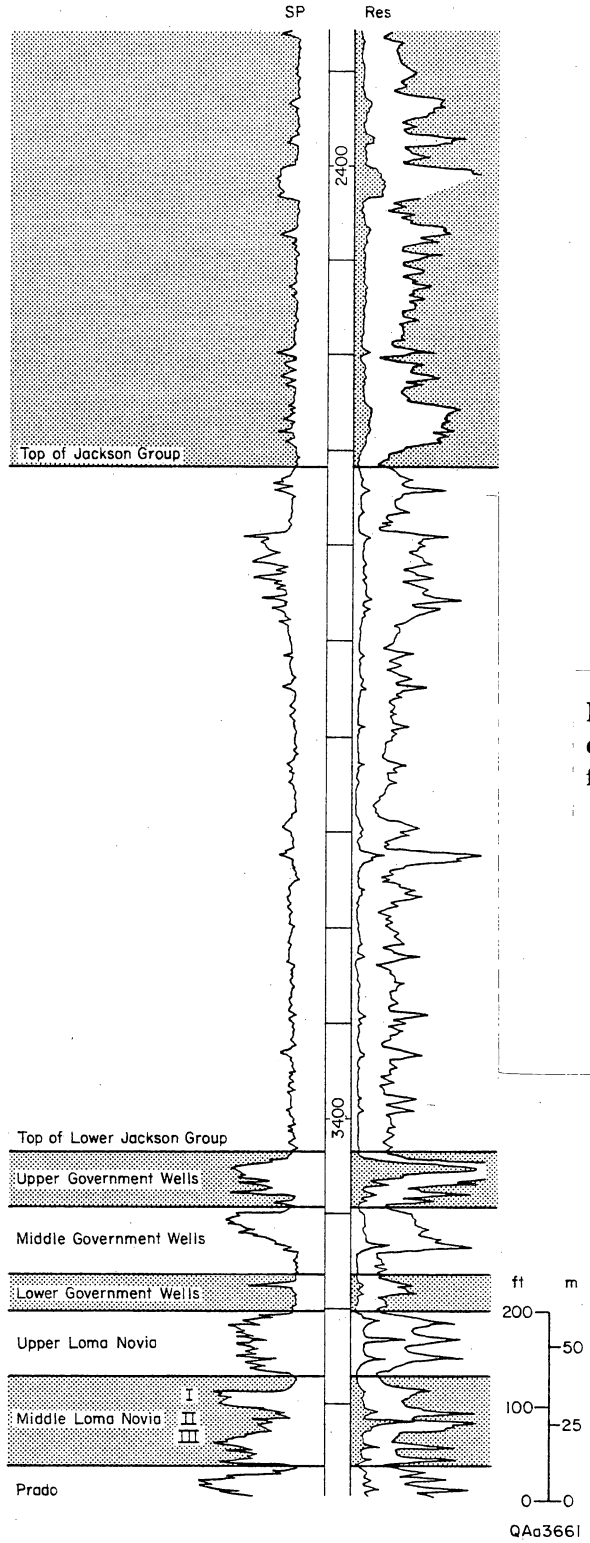


Figure 2. Typical log from Prado field showing electric log characteristics and field-specific nomenclature of upward-fining sand bodies.



Table 1. Engineering characteristics, Prado field.

PRADO FIELD	Main Gas Reservoir	Main Oil Reservoir
Reservoirs	Upper Government Wells	Middle Loma Novia
County	Jim Hogg	Jim Hogg
Discovery	July 1956	July 1956
Hydrocarbon type	gas	oil
Depth subsea	2,800 ft	3,050 ft
Porosity (ave.)		31.70%
Permeability (md ave. and range)		906 md (55-5946)
Area	3,275 acres	2,076 acres
Net pay	20 ft	28.5 ft
Reservoir pressure (initial)		1,407 psig
Reservoir pressure (current)		1,082 psig
Estimated original gas/oil in place	35 bcf	68.3 mmbbl
Water saturation		26%
Bubble point		1,407 psi
Formation factor		1.2045
Temperature		109°F
Oil gravity		39.6
Transmissibility		1,667 md-ft/cp
Target oil	650 mmcf/acre-ft	384 stock tank bbl/acre-ft
Cumulative production	25,277,059 mcf	23,474,000 bbl
Production in 1991	0 mcf	2,200 bbl
Well spacing	200 acres/well	13 acres/well
Drive	gas cap, pressure depletion	gas cap, solution gas, weak water drive
Stage of depletion	tertiary	secondary
Secondary production	none	waterflood

assemblages of upward-coarsening and upward-fining sand bodies and interbedded mudstone. The Government Wells (Upper and Lower) and Upper Loma Novia reservoirs are much more homogeneous, upward-coarsening sand bodies. Detailed characterization of the reservoir sandstones follows in the section "Sand-Body Architecture and Depositional Systems."

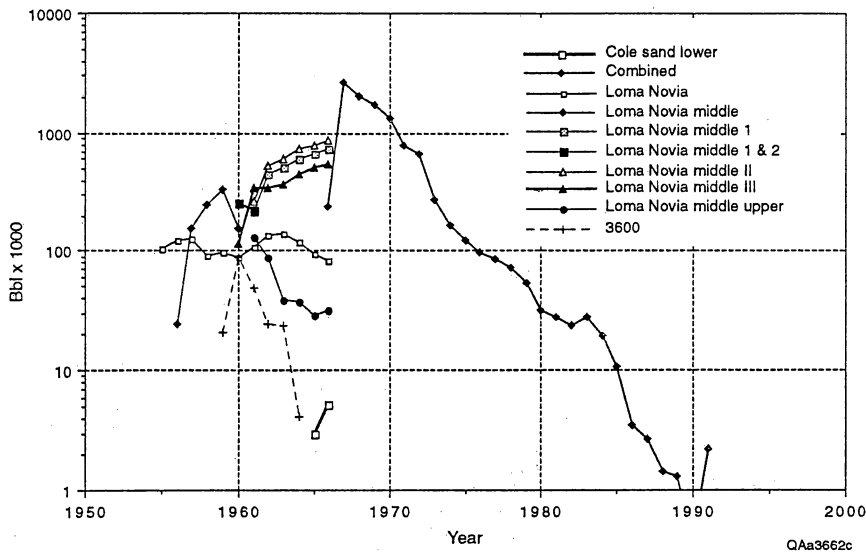
### Production History

According to Railroad Commission of Texas (RRC) annual reports, 16 reservoirs have produced oil or gas in Prado field. The Upper Government Wells is the principal gas reservoir, whereas the Middle Loma Novia is the principal oil reservoir. The RRC merged the nine oil reservoirs into a single combined reservoir for reporting purposes in 1967 (fig. 3). Gas production peaked in 1962 at 7.183 million mcf/yr and has since declined steeply. Prado oil production peaked in 1967 at 2.66 million bbl/yr. Oil production has declined steeply since 1967, the steepest decline occurring after 1983. Current oil production in 1991 increased to 2,200 bbl/yr from 294 bbl in 1990. The decline in gas production preceded that of oil production, but gas production recovered slightly and held steady at about 31,750 mcf/yr from 1978 to 1985 as gas was produced from the gas cap of the Middle Loma Novia reservoirs. Post-1985 gas production has plummeted, with no gas production reported from 1988 to 1991.

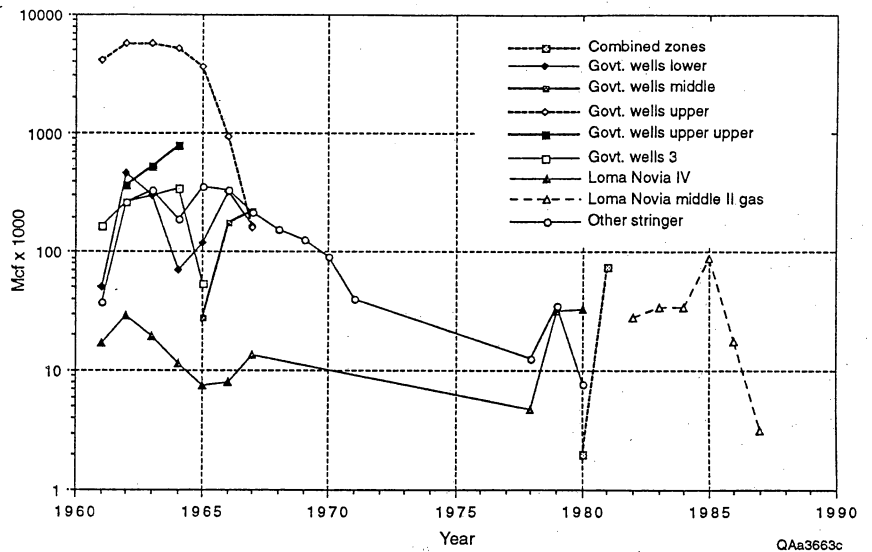
The initial potential of most wells completed in Loma Novia reservoirs ranged from 60 to 120 bbl/d (fig. 4), and most wells initially produced 80 to 100 bbl/d. Wells with low initial potential (less than 80 bbl/d) are concentrated on the updip and downdip margins of the field. Wells in the center of the field with high initial potential (greater than 100 bbl/d) are dip aligned.

In 1961, the RRC granted the field operator authority (Special Order No. 4-45,735) to inject gas and water into the reservoir in order to maintain reservoir pressure. Initially, gas produced from the Upper Government Wells reservoirs was reinjected into the gas cap of Middle Loma Novia reservoirs. After depletion of the Upper Government Wells gas reservoir, a program of water injection for pressure maintenance was begun in 1967. Initially, producing wells on the downdip side of the field that watered out were converted to injection wells. Later, producing wells from the center of the field were converted to injection wells. The reservoir did not respond favorably to the water injection program, and production

(a)



(b)



(c)

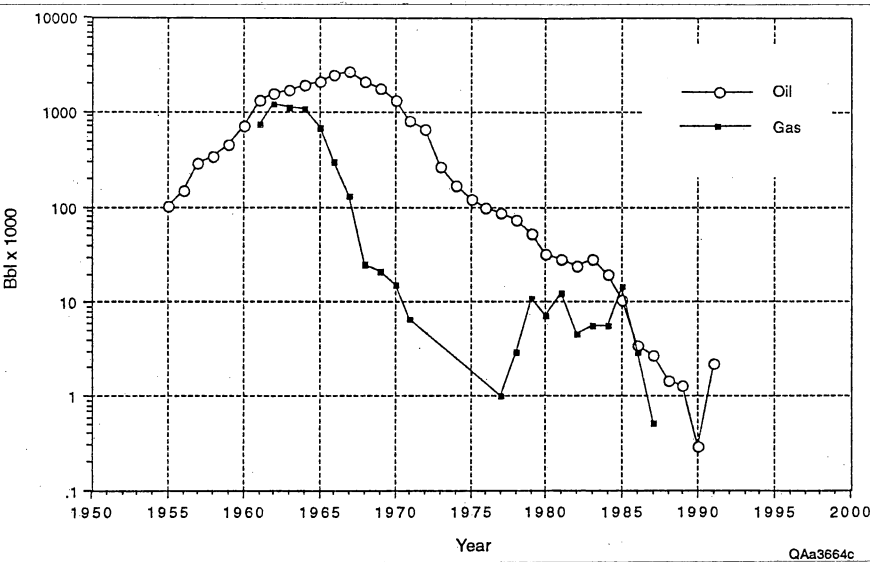


Figure 3. Production history of Prado field from Railroad Commission of Texas annual reports. Figure 3a and 3b show production for individual oil and gas reservoirs, respectively. Figure 3c shows fieldwide cumulative oil and gas production.

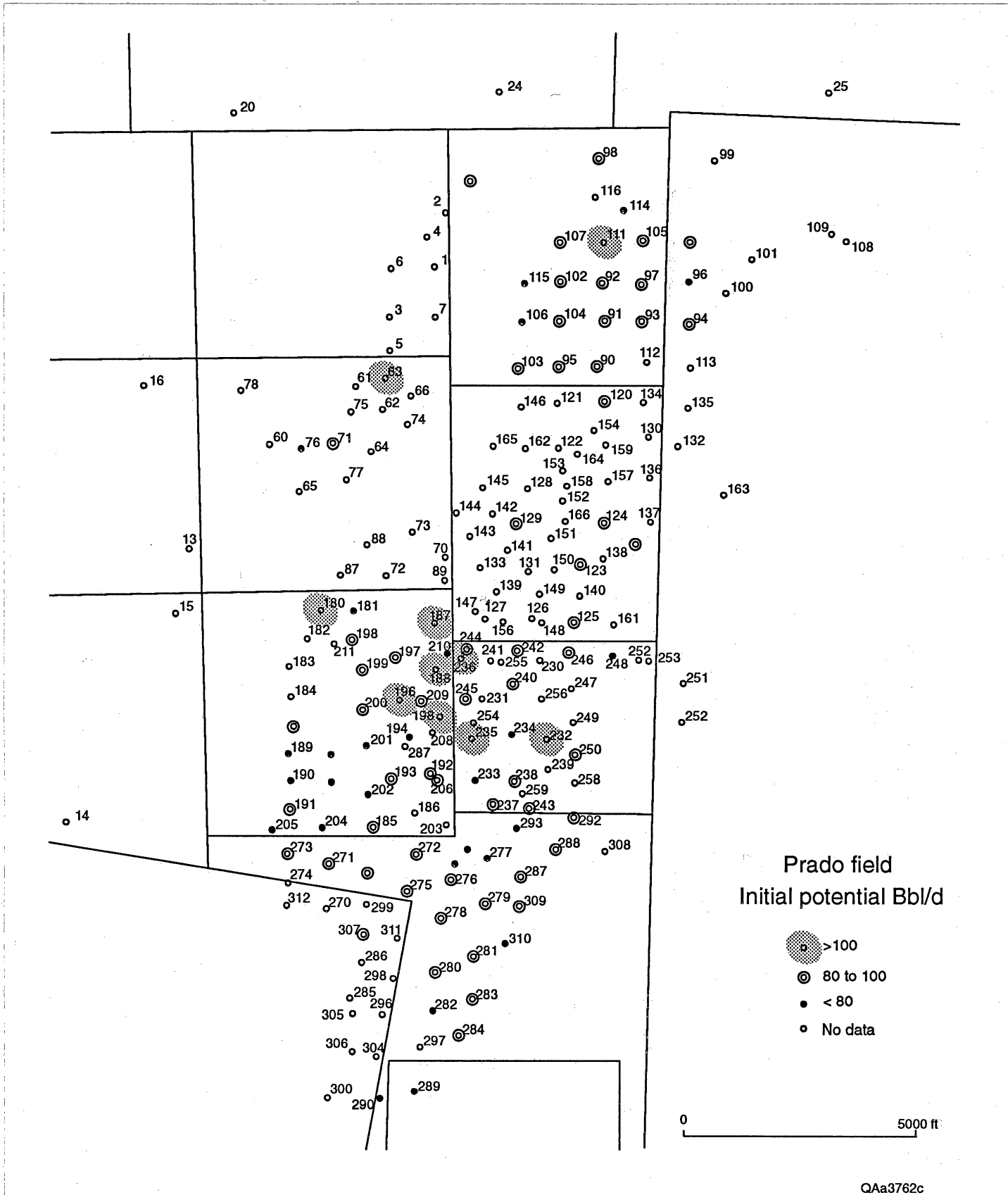


Figure 4. Map showing initial potential reported for wells in Prado field.

declined at an increasing rate after 1970. The volume of water that was injected is unknown.

Unfortunately, more detailed production records are unavailable. Production is reported to the RRC by lease but not by well. Because all the wells in Prado field are on a single lease (no. 06673 East S. K.), further subdivision of production records was impossible. Ownership of the field has changed hands repeatedly, and production records from the original operators are unavailable, even to the current operator (Chase Petroleum and PI Energy, Inc.).

## GEOLOGIC CHARACTERIZATION

Abundant subsurface well log data are available for detailed geologic characterization of Prado field. Data from more than 300 well logs and scout cards are plotted in the immediate vicinity of Prado field. Subregional well data from the surrounding five-county area of Duval, Jim Hogg, Webb, Starr, and Zapata Counties are also available (Seni and Walter, in press). Pertinent geologic data for computerized mapping of structure, thickness, net sandstone, and percentage sandstone are organized in a geographic information system (GIS). Well control is illustrated on a structure-contour map on the top of the Jackson Group (fig. 5). Appendix 1 lists well index numbers and well names. Appendix 2 lists well names shown on cross sections.

Well logs are the primary means of subsurface analysis of the structure and depositional systems of Prado field. Local cores were unavailable, but log descriptions of well cuttings helped confirm the presence of lignite. Subsurface well control is dense. Average well spacing is 20 acres/well. Most wells were 1 inch to 100 ft SP-resistivity logs. Two-inch and 5-inch SP-resistivity logs were also used where available. Data interpreted from individual logs were incorporated into a GIS. Such data include tops, isopachs, net sandstone, and percent sandstone from the following sequences—Jackson (top only), Upper Government Wells, Middle Government Wells, Lower Government Wells, Upper Loma Novia, middle Novia, Prado, and Pettus. Data from ARCInfo GIS and contouring packages from Radian CPS were used to generate a variety of maps depicting the structure, depositional facies variations, and upward-fining architecture.

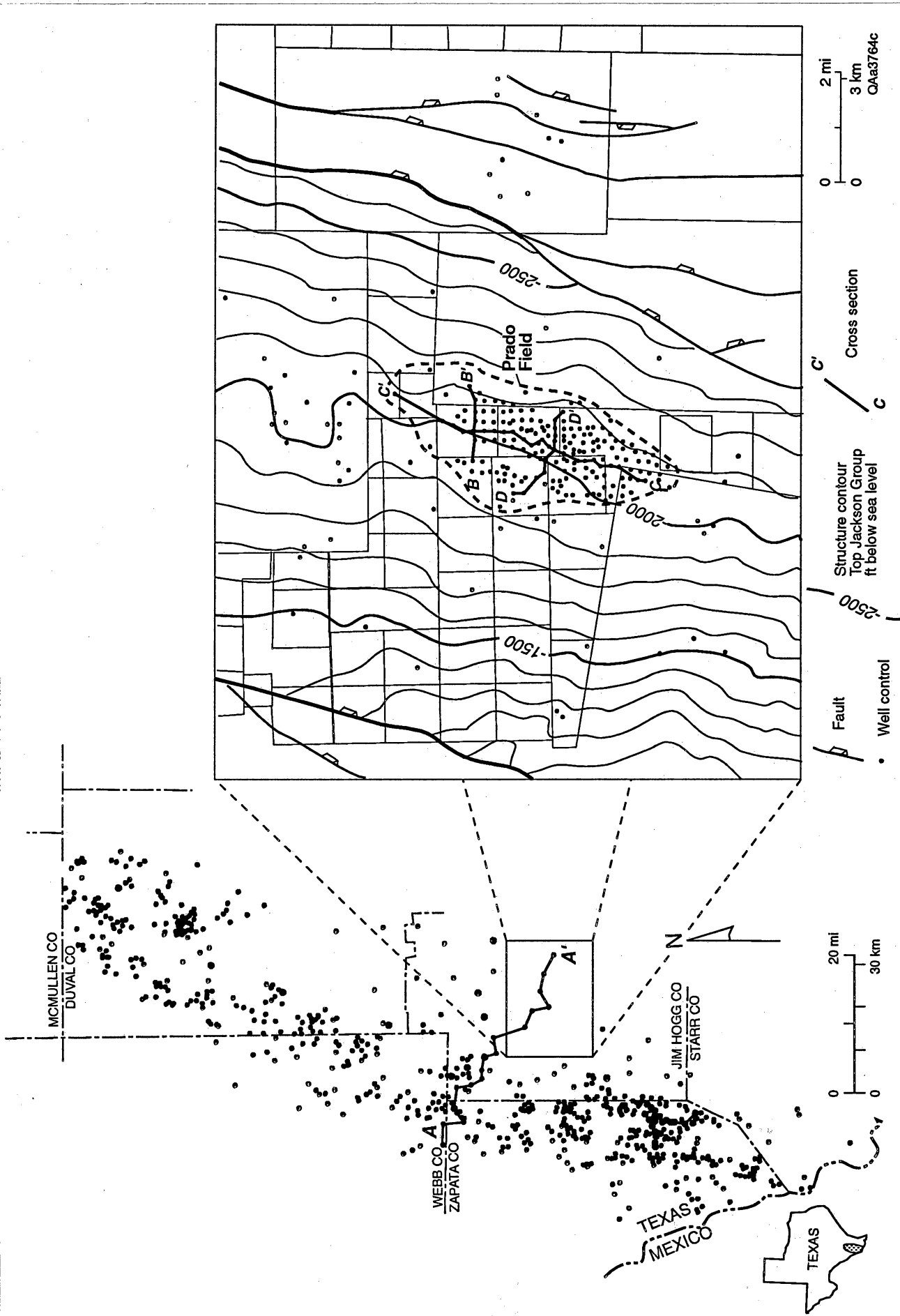


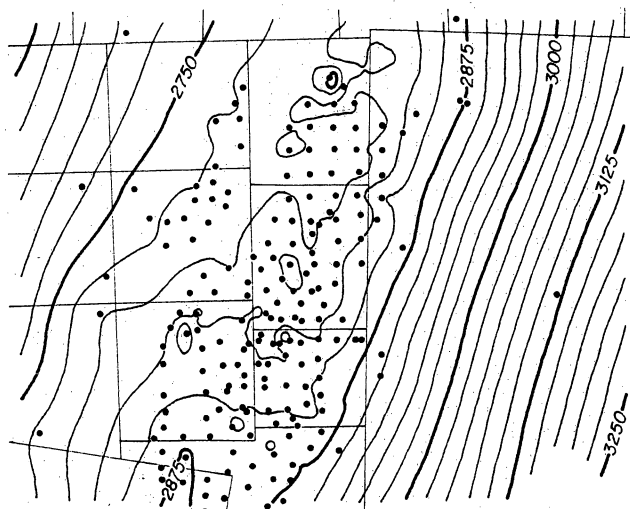
Figure 5. Well control and general structural configuration for area around Prado field, Jim Hogg County, South Texas. Inset map shows regional distribution of available well control.

## Structure

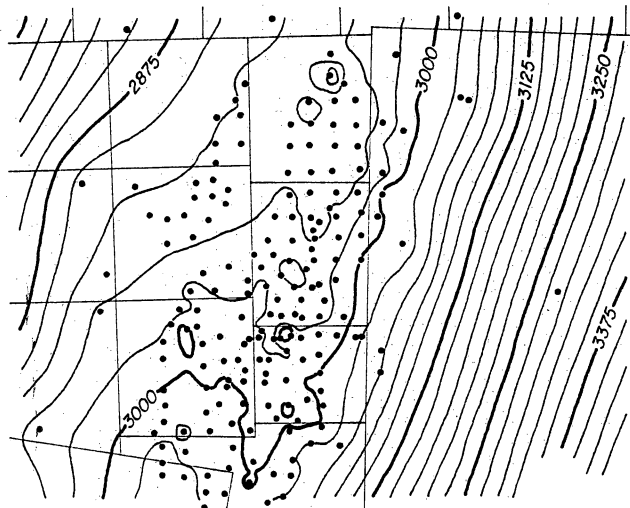
Although the structural aspects of Prado field are less complex than the stratigraphic depositional features, pronounced variations in the thickness and percentage sandstone of the Lower Jackson are inferred to have caused subtle structural drape over the area of the field and thus contributed to localization of the field. The Prado field area lies between the Wilcox and Frio growth fault zones in South Texas (fig. 5). In the immediate area of the field, no large faults or major structural discontinuities are evident on the scale of regional structure maps. The top of the Jackson dips east-southeast at the rate of 200 ft/mi. Because the trend of the updip pinch-out of sandstone coincides with the structural dip, an additional lateral barrier to migration is needed to close the trap, especially to the north. At Prado field, the northern closure results where the sandstone pinch-out line crosses structural contours, that is northern closure occurs where the sandstone pinch-out line swings east and plunges down structure.

Within Prado field, detailed structural mapping of individual horizons reveals the progressive development of a structural high across the field that increases in amplitude from oldest to youngest units as a result of compaction over the sand-rich core of the field (fig. 6). The top Prado is the oldest sandstone mapped in the field area because of the lack of deeper control on the Yegua Formation. The structure-contour map illustrates the relatively planar surface of the top of Prado sandstone and the dip to the southeast of 75 to 100 ft/mi. The structure of younger sand bodies in the Prado field illustrates the progressive development of a structural nose with a relief of up to 25 to 30 ft. This structural component of Prado field is also seen on a stratigraphic dip section across the field (fig. 7). Again the monoclinial basinward dip of horizons is interrupted across Prado field where lower Jackson sand bodies have accumulated a relatively thick, sandy interval, presumably as a result of stabilization of the paleoshore line. The tops of youngest sandstones are folded in a gentle anticline that achieves its greatest relief where the sandstone percentage is the thickest.

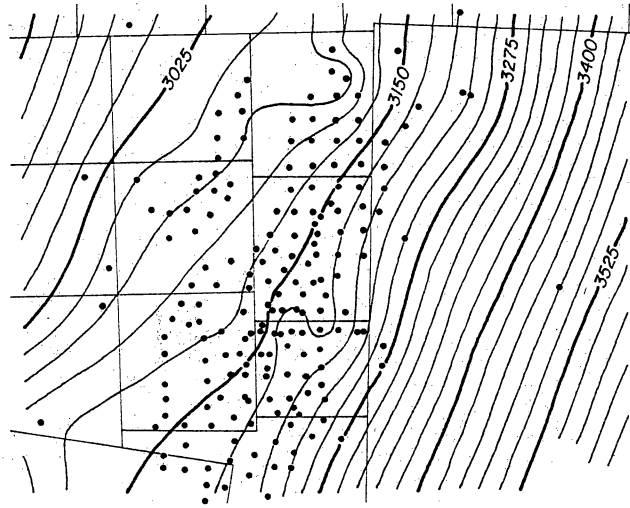
Minor intrafield structural saddles along the updip margin of Prado field supports the interpretation that changes in sandstone thickness and percentage also affect intrafield structure. Figure 8 is an operator-supplied structure-contour map (RRC Docket Number 4-55,323) of the Middle Loma



Upper Government Wells



Upper Loma Novia



Prado

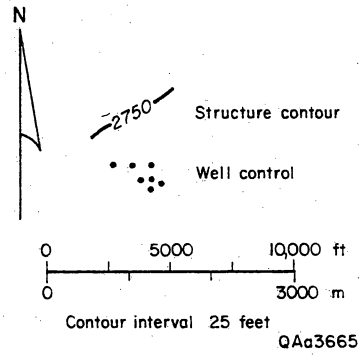
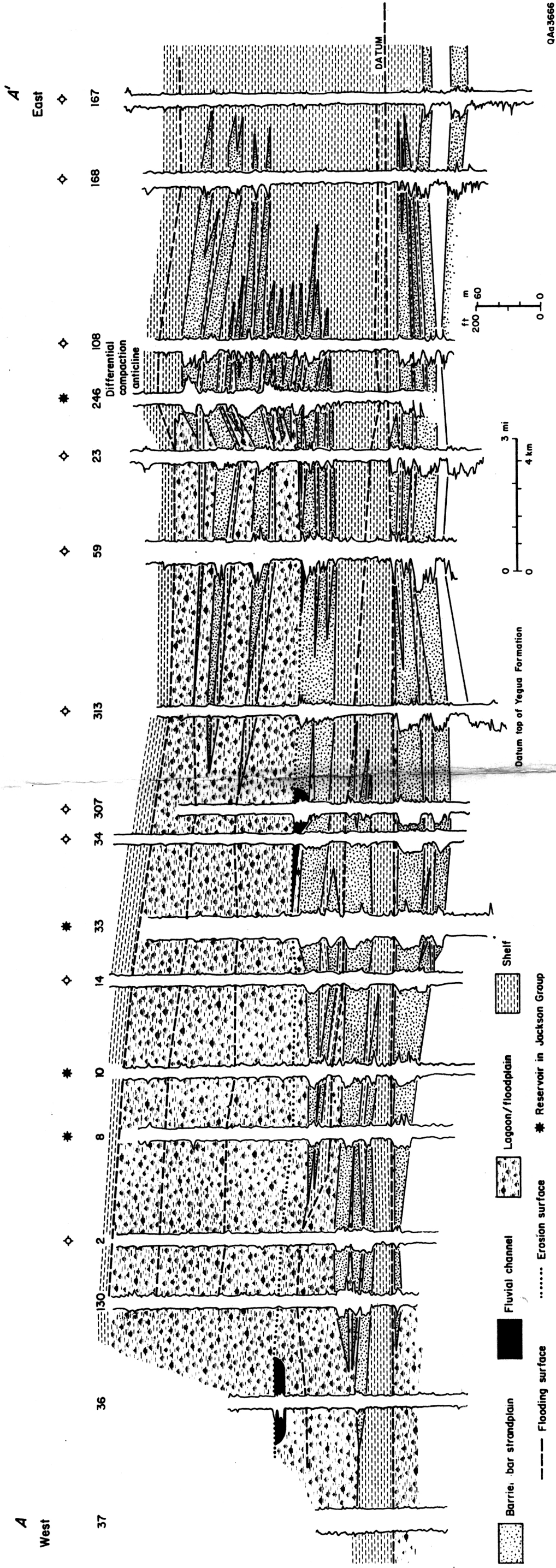


Figure 6. Structure-contour maps of Upper Government Wells, Upper Loma Novia, and Prado reservoirs, Prado field. Development of structural nose in field area is a result of drape compaction over thick, sand-rich Middle Loma Novia reservoirs.





QAa3666

Figure 7. Stratigraphic dip-oriented cross section, Prado field area. All lower Jackson sandstones pinch out updip, and individual reservoir sandstones display a basinward-stepping geometry.

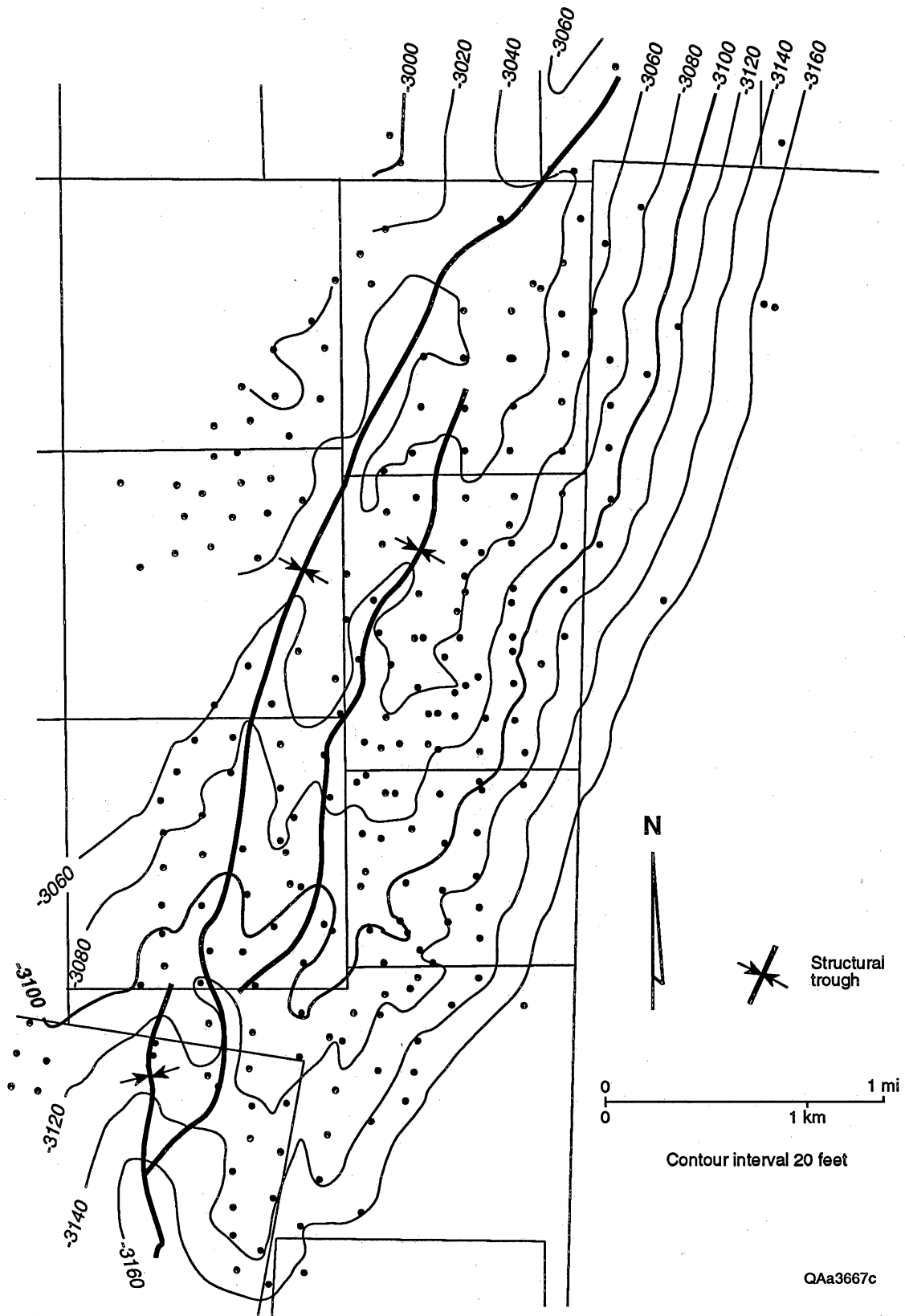


Figure 8. Structure-contour map of top Middle Loma Novia II sandstone. A structural trough on the updip margin of the field is another example of drape compaction over zone between mud-rich lagoonal facies updip and sand-rich barrier facies downdip. Modified from Railroad Commission of Texas docket no. 4-55,323.

Novia II sandstone that illustrates a series of gentle folds (amplitude of 10 ft) striking north-northeast and open to the south. The folds affect the structural level of the tops of horizons from the Middle Loma Novia through the Upper Government Wells. A dip-oriented structural cross section across the updip part of the field illustrates monoclinical dip on the top of the underlying Prado sandstone, whereas younger intervals are structurally low along the updip part of the field and are structurally high along the central axis of the field (fig. 9). The cross section (fig. 9) shows that the transition from the structure trough of the fold to the crest is associated with both a rapid increase in thickness and facies change in the Middle Loma Novia interval. The trough of the syncline is clearly associated with the updip pinch-out of relatively thick sand-rich, back-barrier sandstones into relatively mudstone-rich lagoonal sediments. The facies change is associated with changes in the thickness of the Middle Loma Novia interval toward the central axis of the field. The decrease in percentage sandstone allowed greater compaction of mudstone-rich sediments along the axis of the syncline. The syncline marks a distinct line of facies change from relatively sand rich back-barrier facies basinward to relatively mud rich lagoonal facies landward of the syncline.

#### Depositional Framework

A series of reports describe the stratigraphic nomenclature (Sellards and others, 1932; Murray and Wilbert, 1950; Eargle, 1959), depositional systems (Fisher and others, 1970; Kaiser, 1974; Kaiser and others, 1980), and resource distribution (West, 1963; Fisher and others, 1970; Kaiser, 1974; Kaiser and others, 1980; Galloway and others, 1983) of the Eocene Jackson Group in South Texas. The Jackson Group includes the section above the Eocene Yegua Formation and below the Oligocene Frio Formation. Murray and Wilbert (1950) described the stratigraphy of the Jackson Group in the central Gulf region, and Eargle (1959) described the stratigraphy in the south-central Texas region. In the South Texas region, from Atascosa and Live Oak Counties to the Rio Grande, the section of the Jackson Group that contains the productive sandstones in Prado field is informally referred to as the lower Jackson (Kaiser, 1974). Although a detailed treatment of the formal stratigraphic nomenclature of the Jackson Group is beyond the scope of this

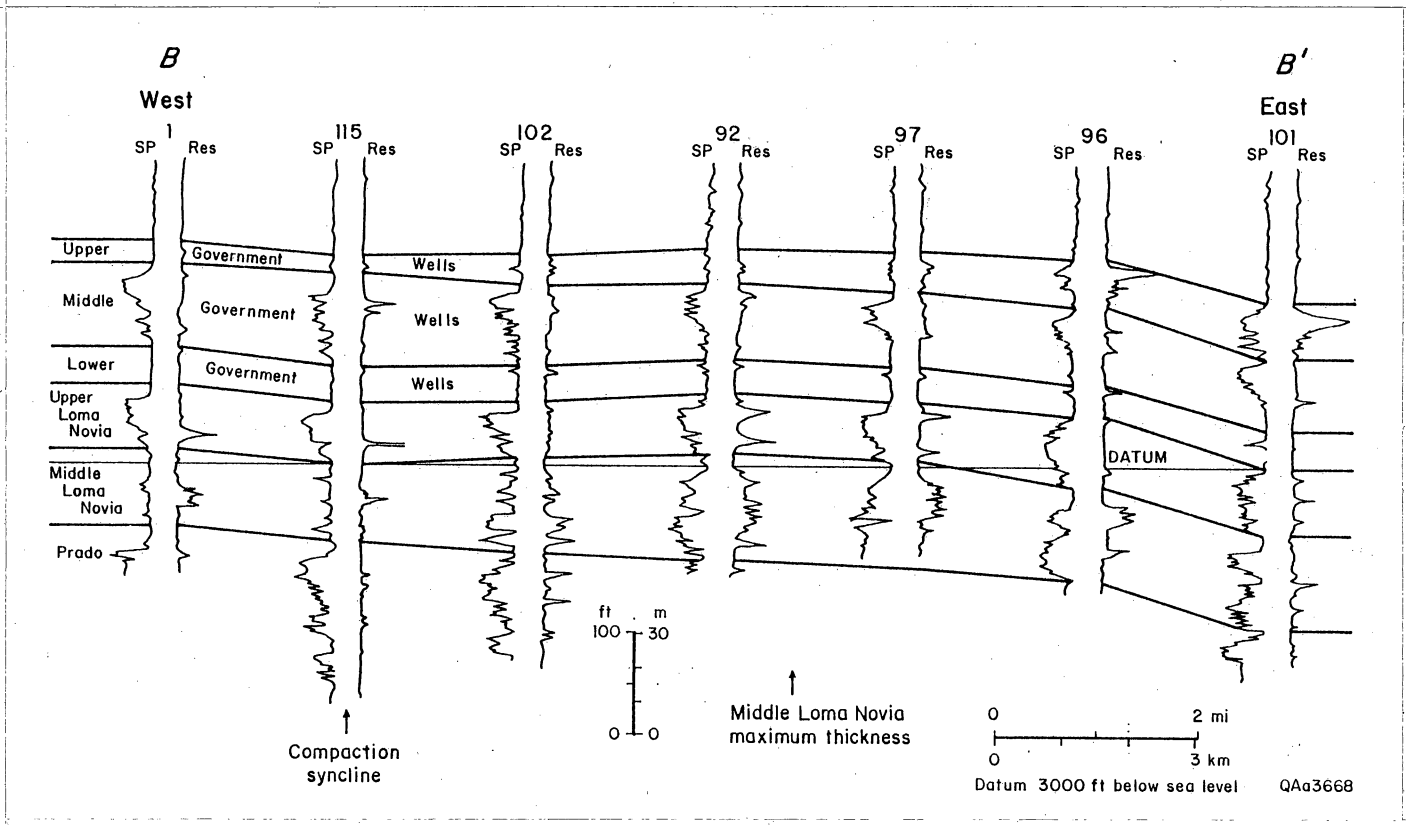


Figure 9. Structural cross section showing structural crest over sand-rich Middle Loma Novia interval.

paper, a brief description of the informal names of laterally extensive sandstones is helpful for understanding the stratigraphic framework. West (1963) described the informal nomenclature of the strike-persistent sand bodies. In South Texas, the Jackson Group includes 1,000 to 1,500 ft of sandstone and mudstone. The lower Jackson contains three to five strike-elongate sand bodies up to 60 ft thick interbedded with subequally thick mudstones and underlain by 50 to 200 ft of regionally extensive mudstone immediately overlying the Yegua Formation. These sandstone bodies are informally referred to in ascending order as the Pettus, Mirando, Loma Novia, and Government Wells sandstones. A regionally extensive mudstone sequence 400 to 600 ft thick separates the sandstones of the lower Jackson from Cole sandstones in the upper Jackson. Jackson Group sand bodies typically are laterally persistent, strike-oriented sandstones that grade updip and downdip into mudstone. A regional net-sandstone map (Kaiser and others, 1980) of the lower Jackson in South Texas (fig. 10) illustrates the linear, strike orientation of the sandstone trends. In Zapata and Jim Hogg Counties, two linear high-percentage sandstone trends are apparent—an updip trend along the Zapata/Jim Hogg County line and a downdip trend in central Jim Hogg County where Prado field (15) is located. These sands are the framework of the South Texas barrier-bar strandplain system (Fisher and others, 1970).

Fisher and others (1970) first described the Jackson Group in terms of three-dimensional assemblages of component depositional systems and genetic depositional facies (Fisher and McGowen, 1969). In the South Texas region, Fisher and others (1970) describe three depositional systems: the South Texas strandplain-barrier bar system, the South Texas lagoonal-coastal plain system, and the South Texas shelf system. The South Texas strandplain-barrier bar system is composed primarily of strike-trending sand bodies interbedded with marine and lagoonal mudstones. Landward of the strandplain-barrier bar system, the lagoonal-coastal plain system is composed primarily of mudstone and minor sandstone. Gulfward of the strandplain-barrier bar system, the South Texas shelf system is composed of marine muds derived from the Fayette fluvial-delta system to the northeast. For the purposes of this report, the South Texas depositional systems will be integrated and the predominantly mudstone lagoonal and shelf systems will be described as facies within the framework of the barrier-bar strandplain system.

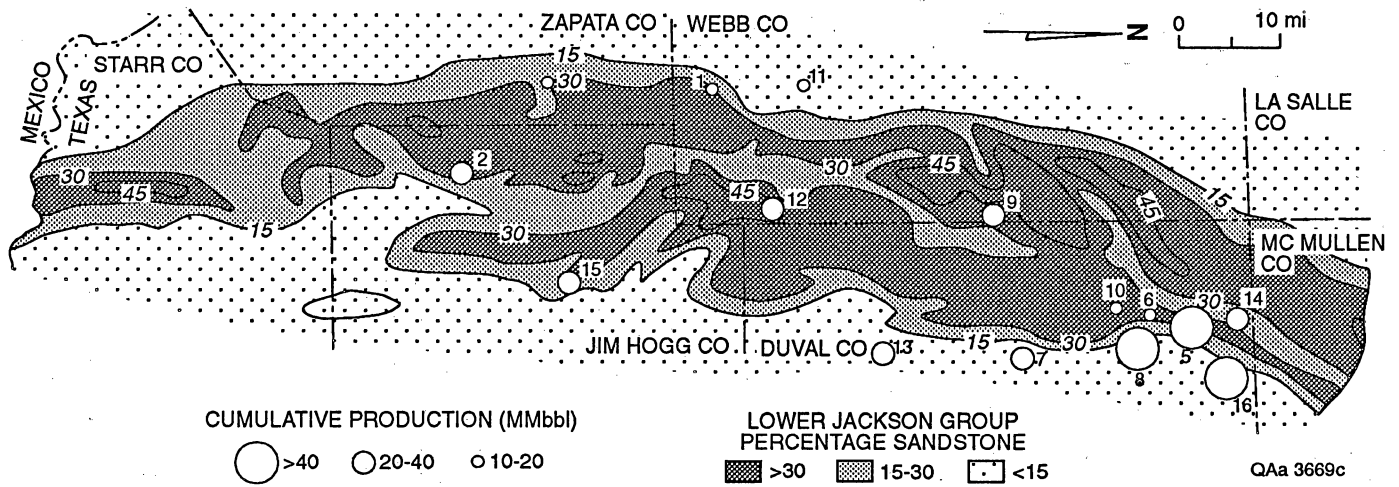


Figure 10. Percent-sandstone map of lower Jackson Group and distribution of major Jackson oil reservoirs. Numbers refer to specific fields located in figure 1. Modified from Kaiser and others (1980).

Updip pinch-outs of strike-elongate, Jackson Group sand bodies have been targets for shallow hydrocarbon exploration for over 70 years (West, 1963). Prado field exhibits the trap style of updip sandstone pinch-out that is typical of Jackson Group reservoirs. The production and reservoir geology of oil and gas fields in the Jackson Group have been described for individual fields (Schultz, 1986; Hyatt, 1990; Hamilton, in press) and groups of fields (West, 1963; Fisher and others, 1970; Galloway and others, 1983; Seni and Walter, in press). According to Galloway and others (1983), average porosity and permeability for the largest Jackson-Yegua barrier/strandplain reservoirs are 31 percent and 604 md, respectively. A regional cross section shows the overall pattern of updip pinch-out of Jackson and Yegua sandstones across the South Texas region (fig. 7). Even from the wide spacing of the regional cross section (fig. 7), the localization of oil and gas fields by the updip pinch-out of reservoir sandstones is evident. Prado field provides an excellent opportunity to analyze local controls on hydrocarbon entrapment because of the wealth of subsurface data. Prado field has two interesting aspects (1) relatively distal position within the overall trend of lower Jackson production and (2) interesting contrast in heterogeneity among various reservoir sand bodies. The reservoir sand bodies at Prado field include typical broad belts of upward-coarsening barrier/strandplain sandstone, as well as more irregular, narrower belts of complex sand bodies that include upward-fining as well as upward-coarsening sandstones.

#### Sand-Body Architecture and Depositional Facies

In the Prado field area, the lower Jackson is divided into six genetic depositional sequences (fig. 9). The sequences are separated by subregional flooding surfaces within mudstones that form the upper and lower boundaries of the genetic depositional sequence (Galloway, 1989). Each of these genetic depositional sequence includes a subregional sand body that is a hydrocarbon reservoir at Prado field. Sequence boundaries were identified and correlated on the basis of the lowest resistivity markers with regional mudstones (fig. 9). Low-resistivity marker zones are interpreted to represent marine condensed sections within the shelf mudstones. Productive sandstones of the lower Jackson Group in the Prado field area of South Texas comprise a series of six, seaward-stepping, progradational parasequence sets that

downlap a marine flooding surface on the top of the Yegua Formation (fig. 7). Dense well control (45–50 wells/mi<sup>2</sup>) conclusively demonstrates that individual sandstone sequences comprise multiple sand-rich facies in belts 5 to 15 mi wide and extending greater than 50 mi along strike. Strike (fig. 11) and dip (fig. 12) cross sections within Prado field illustrate lateral continuity of individual sandstones and consistent trends in SP log patterns. The dense distribution of wells gives substantial conviction to the upward-fining correlations. Younger sand bodies (Upper Government Wells, Middle Government Wells, and Upper Loma Novia) are laterally continuous in a strike direction and typically comprise upward-coarsening textural trends. In contrast, the older sand bodies (Middle Loma Novia and Prado) typically comprise complex packages of upward-fining and upward-coarsening sandstone and mudstone. Within the area of the field, the Upper Government Wells and Middle Loma Novia sand bodies pinch out updip. Both updip and downdip pinch-out of all other productive sand bodies is demonstrated with well control just outside the field proper.

The vertical stacking relationship of the Middle Loma Novia, Upper Loma Novia, Middle Government Wells, and the Upper Government Wells reservoirs (from oldest to youngest) is evident from stacked percentage-sandstone maps of Prado field (fig. 13). The Prado reservoir was not mapped because most of the wells did not penetrate the entire thickness of that reservoir. The Middle Loma Novia reservoir exhibits the narrowest extent of greater than 50 percent sandstone. The breadth ranges from 3,000 to 7,500 ft. At its narrowest reach, all sandstone within the Middle Loma Novia interval is confined within a belt 5 mi wide. The updip limit of production from the Loma Novia reservoirs coincides roughly with the line of 15 percent sandstone. The upward-coarsening Upper Loma Novia is considerably wider than the Middle Loma Novia. The 50 percent sandstone line extends beyond the field limits to a width of 5 to 8 mi. The line of maximum sandstone percentage in the Upper Loma Novia prograded just downdip of the maximum sandstone line in the underlying Middle Loma Novia (fig. 14). Sandstone in the Middle Government Wells is widely distributed, similar to that of the Upper Loma Novia. The sandstone-percentage map of the upper Government Wells illustrates the basinward progradation of the area of maximum sandstone thickness. The axis of maximum sandstone percentage from prograded basinward 1 to 2 mi (fig. 14) from the oldest Middle Loma Novia to the youngest Upper Government Wells.



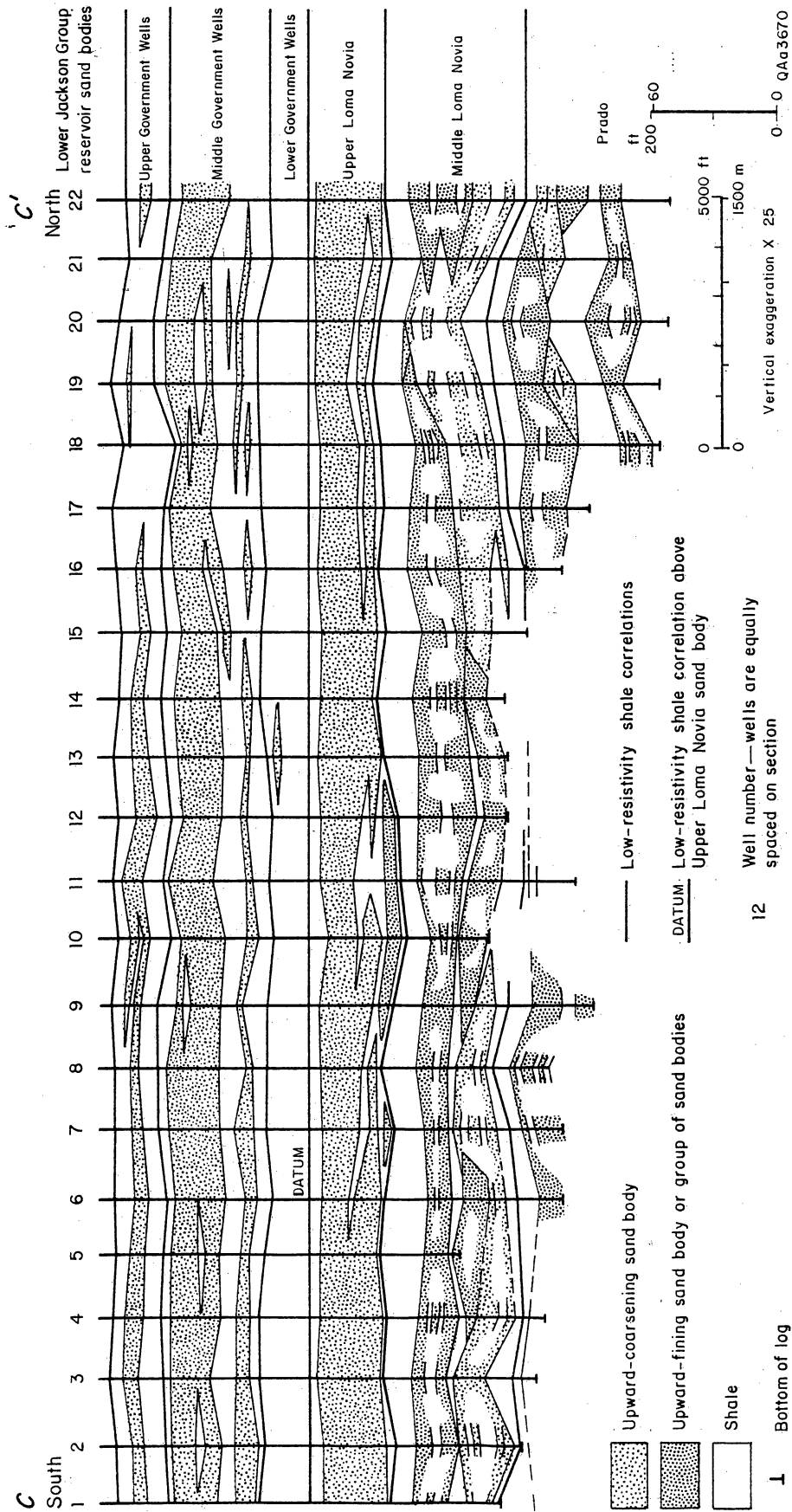
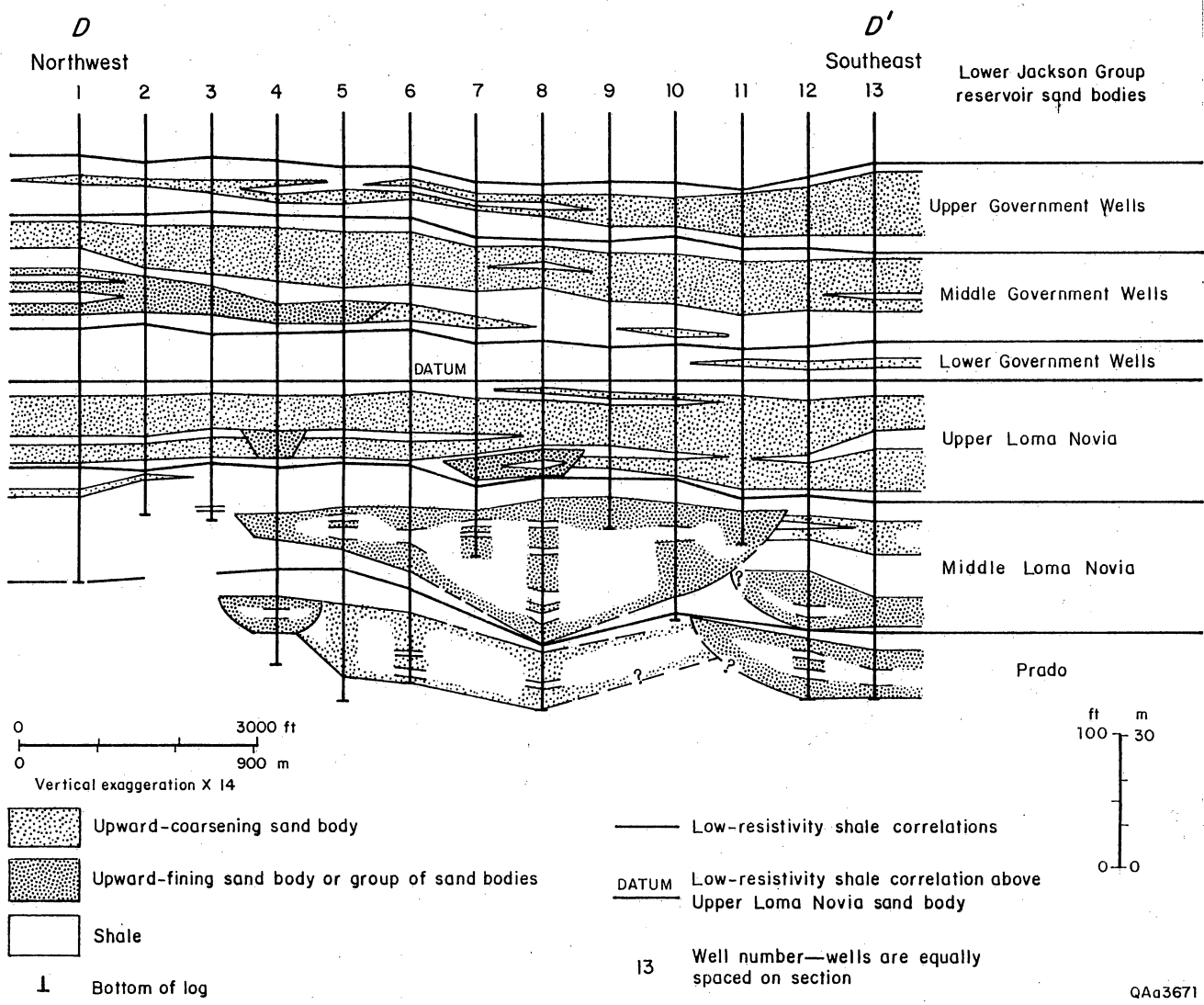


Figure 11. Strike-oriented cross section, Prado field, showing correlation of mapping units and distribution and character of reservoir sandstones. Upper Government Wells, Middle Government, and Upper Loma Novia reservoir sandstones are characteristically upward-coarsening continuous sand bodies. In contrast, Middle Loma Novia and Prado reservoir sandstones are characteristically complex packages of upward-fining as well as upward-coarsening sand bodies.



**Figure 12. Dip-oriented cross section, Prado field, showing correlation of mapping units and distribution and character of reservoir sandstones.**

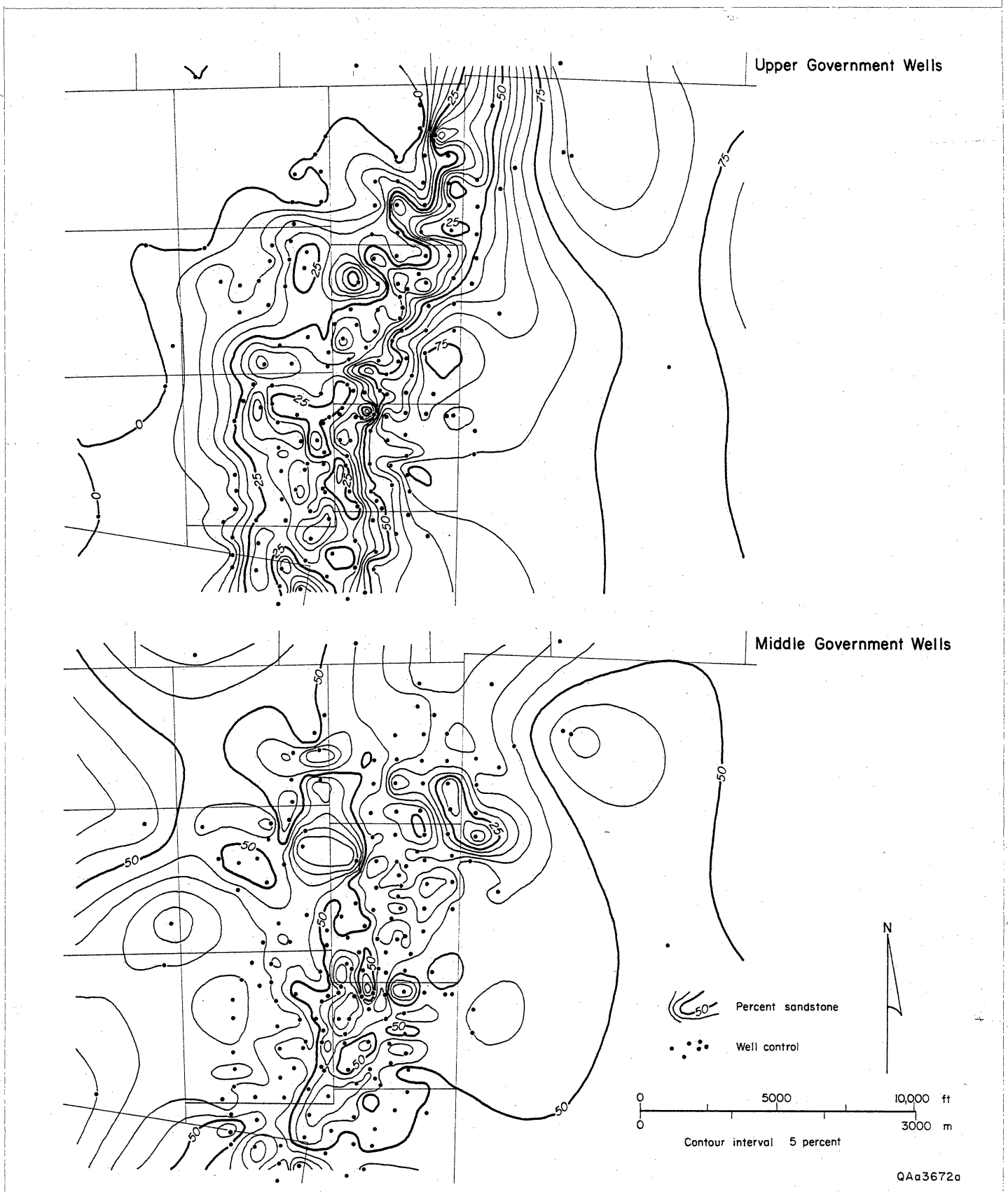


Figure 13. Percentage-sandstone maps for Upper Government Wells, Middle Government Wells, Upper Loma Novia, and Middle Loma Novia reservoir sandstones, Prado field. Maximum percentage sandstone for all intervals trends north-northeast. The area of greater than 75 percent sandstone prograded downdip from the Middle Loma Novia to the Upper Government Wells.

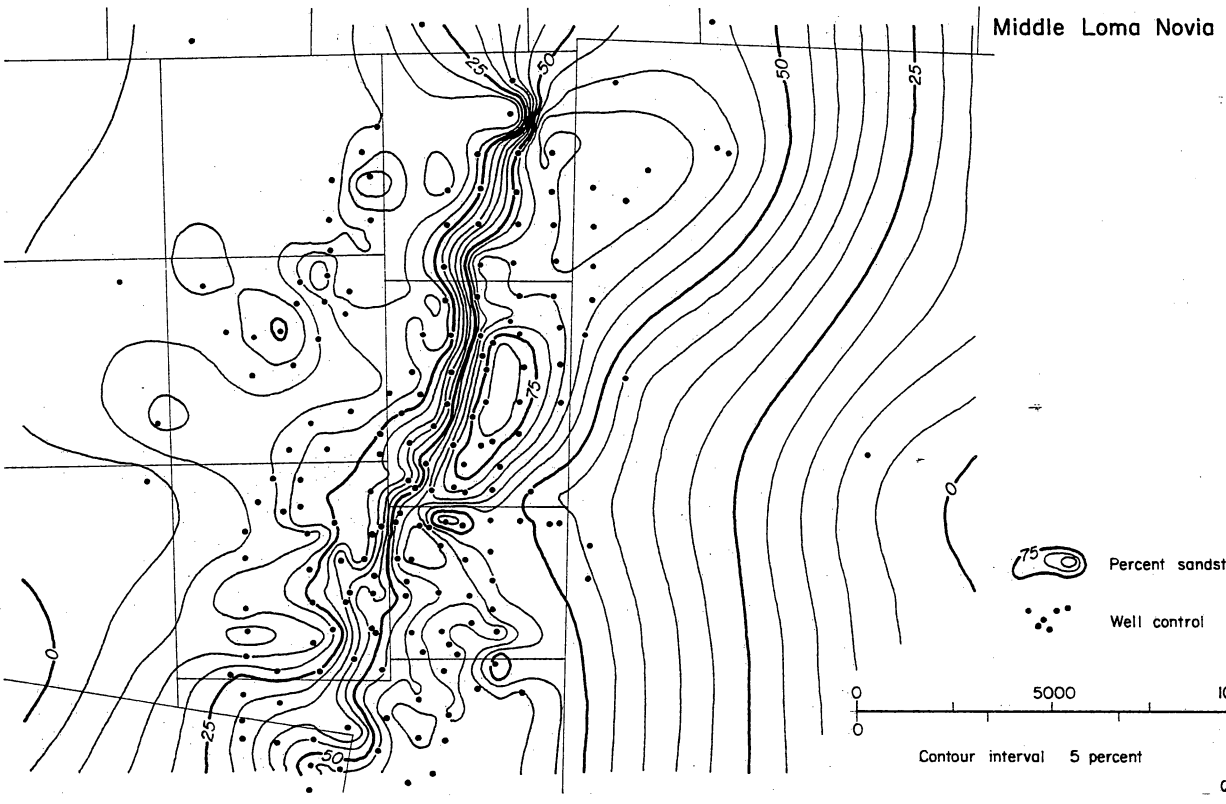
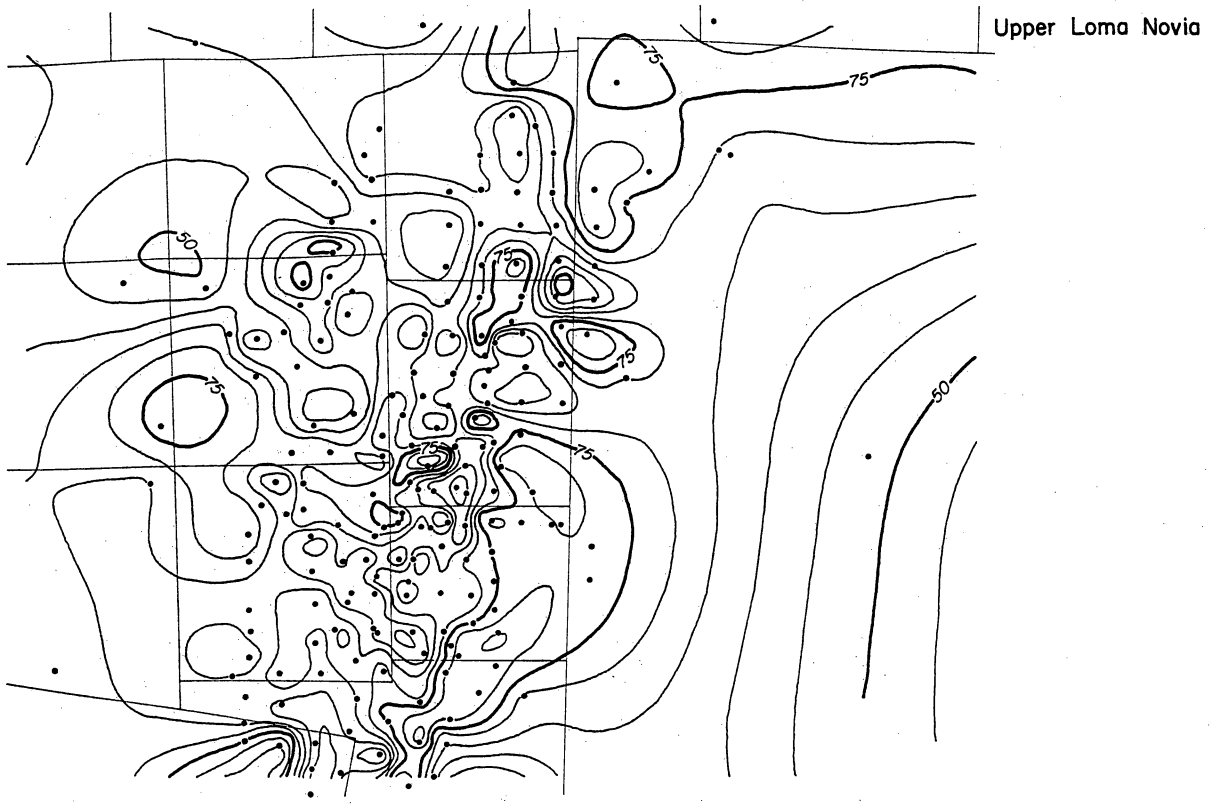
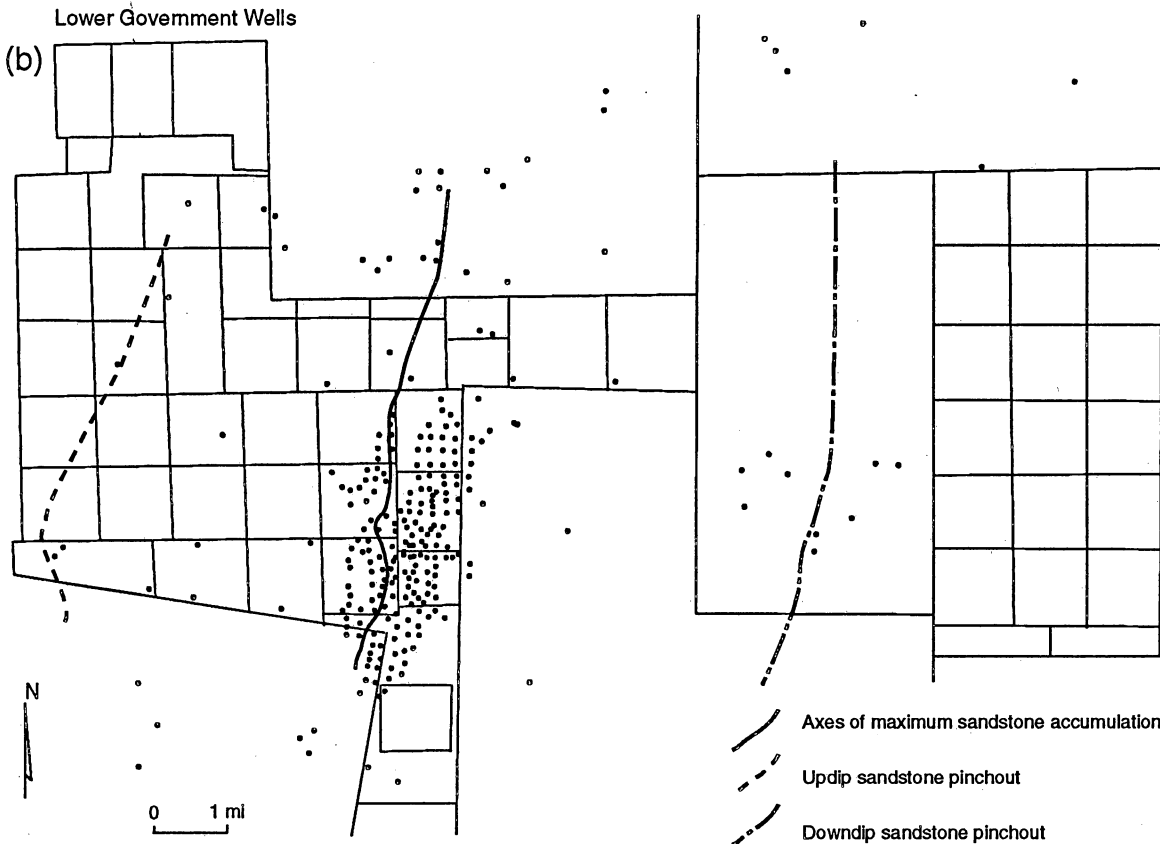
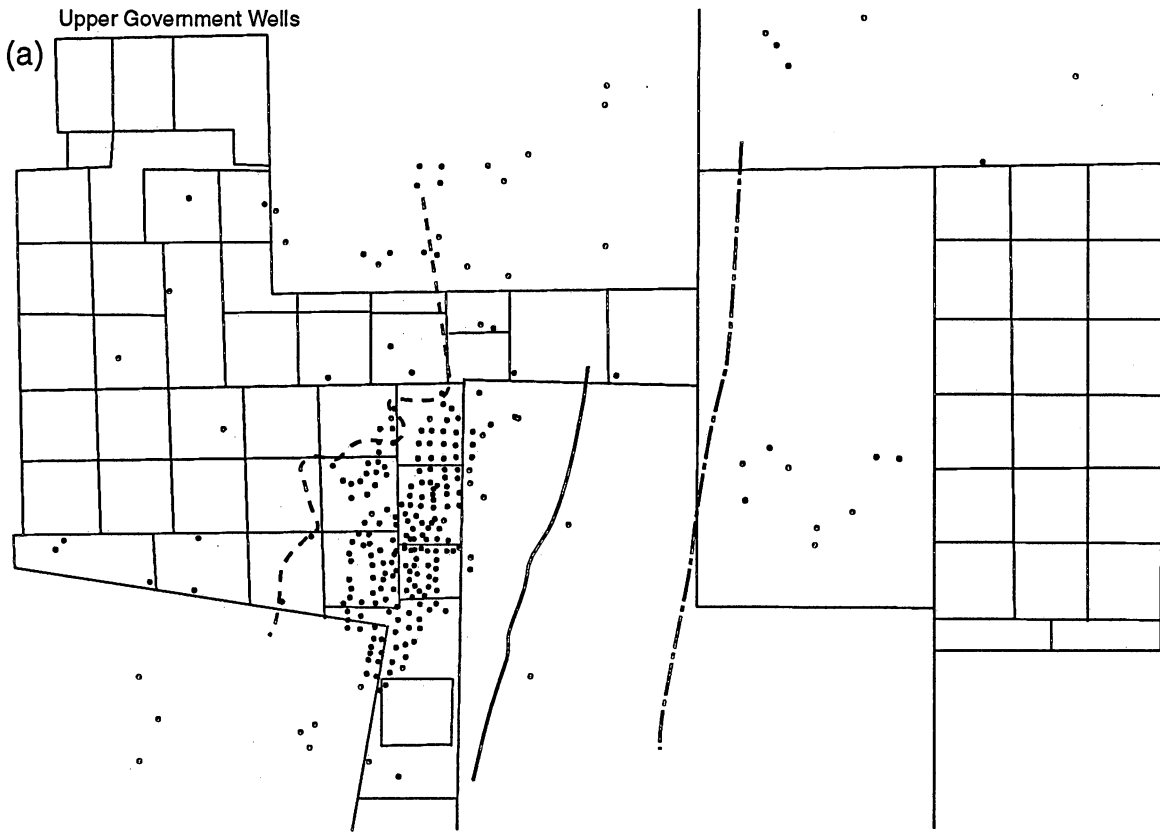


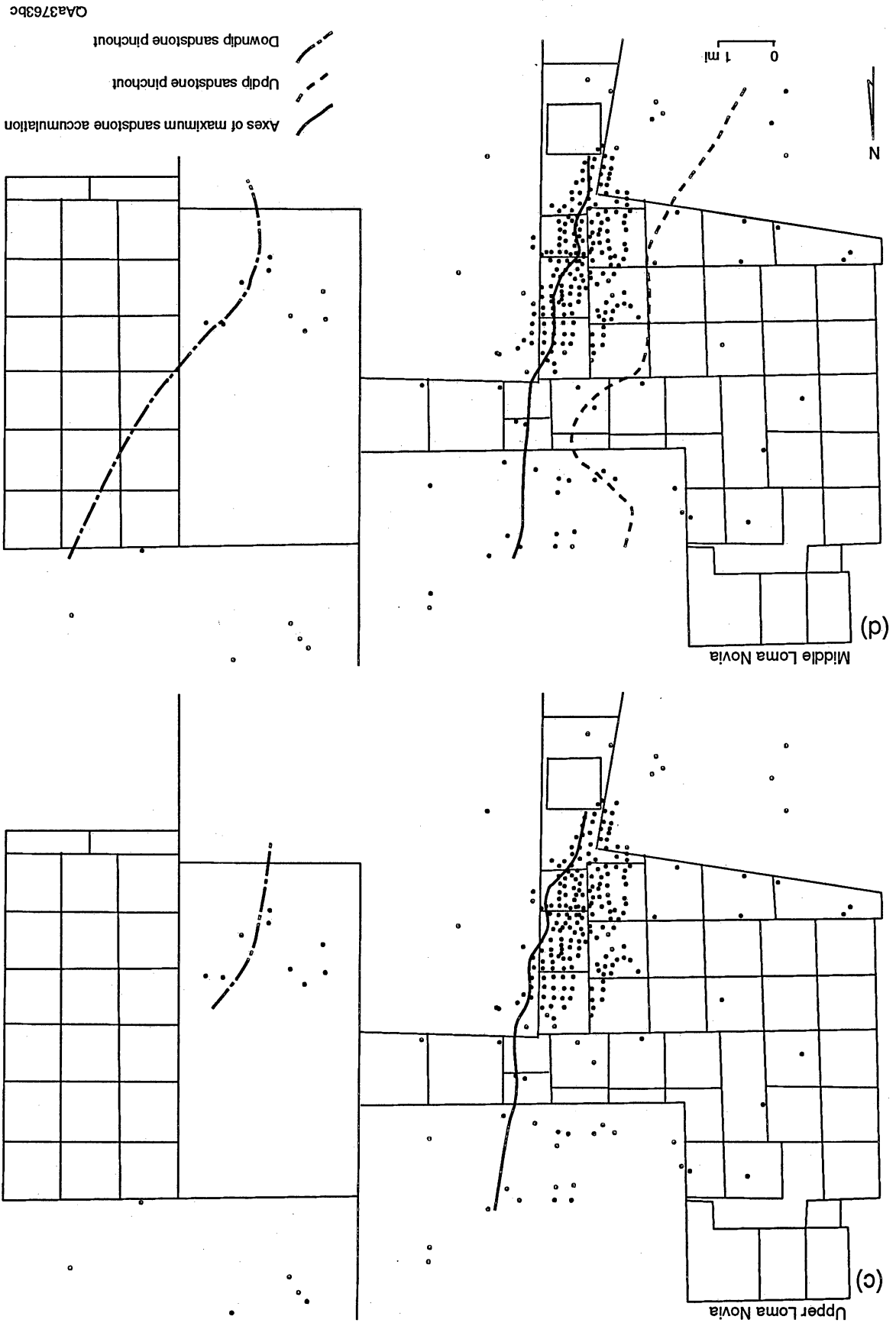
Figure 13 continued.



QAa3763ac

Figure 14. Map of axis of maximum sandstone accumulation and updip and downdip lines marking sandstone pinch-outs.

Figure 14 continued.



QAa3763bc

Regional or local unconformities as a result of rapid relative sea-level falls are difficult to identify solely on the basis of SP response and well log character in the absence of core. However, a possible unconformity surface was identified in association with (1) isolated channel sandstone geometries and (2) basinward facies shift of 15 mi for lower Jackson sandstones overlying shoreline facies. The basinward shift of lower Jackson sandstones can be explained as the forced regression of shoreline position during base-level lowering or possibly during influx of volcanoclastic sediments. This is interpreted to be the cause of the separation of an updip and a downdip strike-oriented sandstone axis on the net-sandstone map of the lower Jackson (fig. 10). Once the forced regression established lower Jackson shorelines in the Prado field area, then shoreline progradation occurred much more gradually and at a diminished rate.

#### Reservoir Models

Reservoir sandstones at Prado field are classified in two end-member depositional models as a result of variations in the types of barrier systems that have developed: (1) an unsegmented barrier-bar model and (2) a tidal-inlet fill model. Middle Government Wells, and Upper Loma Novia reservoirs are characterized by the unsegmented barrier-bar model, whereas the Middle Loma Novia and Prado reservoirs are characterized by tidal-inlet fill model. The Upper Government Wells is intermediate, having characteristics of both models. The younger, unsegmented barrier-bar sand bodies overlie the two older tidal-inlet fill sand bodies. The unsegmented barrier-bar reservoirs primarily produce gas by virtue of their structurally high position, whereas the lower tidal-inlet fill sandstones produce oil and some gas.

Galloway and Cheng (1985) described barrier-island depositional systems of the Frio Formation in terms of the architectural elements of a barrier-island sand body (fig. 15). Principal sand-rich depositional environments of the barrier-island sand body include barrier core, inlet fill, flood-tidal delta, washover fan and barrier-flat, and shoreface. These same architectural elements are recognized in Prado field.

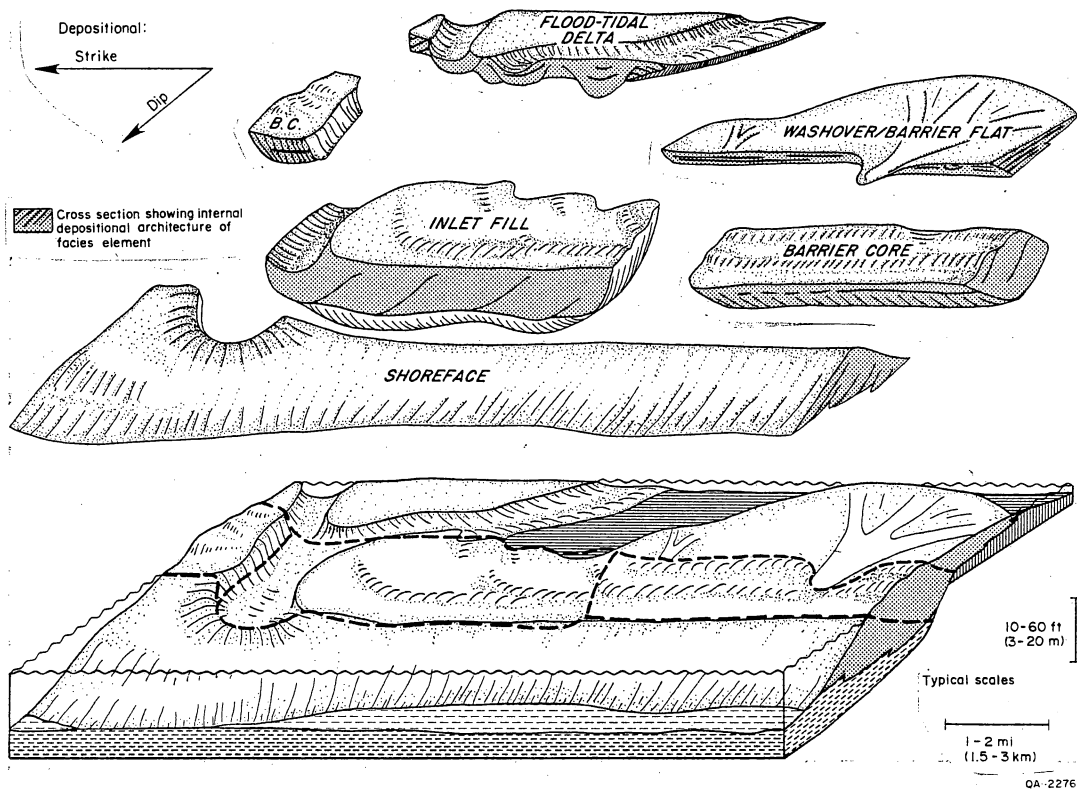


Figure 15. Component depositional facies of barrier-bar sand body. After Galloway and Cheng (1985).



## Log Facies

Log facies have been identified for each of the main reservoir sand bodies at Prado field (fig. 16) and are useful for differentiating reservoir characteristics and models (figs. 11 and 12). Log facies are defined on the shape of the SP curve (Krueger, 1968; Galloway and Cheng, 1985; Tyler and Ambrose, 1985, 1986; Tyler and others, 1986; Ramos and Galloway, 1990). The SP log is a primary, indirect record of the permeability and thus gross grain-size distribution of the strata as a function of the greater permeability of sandstones when compared to shales. Factors affecting the magnitude of the SP curve include: (1) the ratio between mud resistivity and formation water resistivity, (2) hole size, (3) depth of invasion, (4) bed thickness, (5) lithology of the strata, and (6) formation resistivity. Stratigraphic variables directly affect bed thickness, lithology, and formation resistivity.

On the basis of SP and resistivity log patterns and lateral facies associations, each of the generally upward-coarsening, progradational parasequence sets typically comprise the following facies tract from updip to downdip: A updip mudstone-rich lagoonal/back barrier/floodplain facies, B sandstone-rich shoreface and core barrier-bar and tidal inlet fill facies, and C downdip mudstone-rich shelf facies. A low-resistivity marker zone typically occurs within the basal mudstone. Facies A is located updip of the sandstone-rich facies and increases in sandstone content in a downdip direction. Facies A is interpreted to represent predominantly lagoonal deposits updip of the barrier bar system. Facies A1 is mudstone rich, ranging from 100 percent mudstone to mudstone that contains lignite and rare thin, spikey sandstone interbeds. Facies A1 is interpreted to represent lagoonal mudstones. Facies A2 contains mixed mudstone and spikey to thin blocky sandstone interbeds. Facies A2 is sandier than facies A1 yet is still mudstone dominated. Sandstone interbeds are less than 1 to 10 ft thick and range from spikey to thinly blocky. A core description from facies A2 indicates a fine sandstone bed, 8 ft thick, overlain by a 2-ft lignite. Mean permeability of the sandstone is 446 md (range 32 to 1,900 md, horizontal permeability) and porosity is 30.6 percent (fig. 17). A thin streak of low permeability, highly cemented (indurated) sandstone occurs at

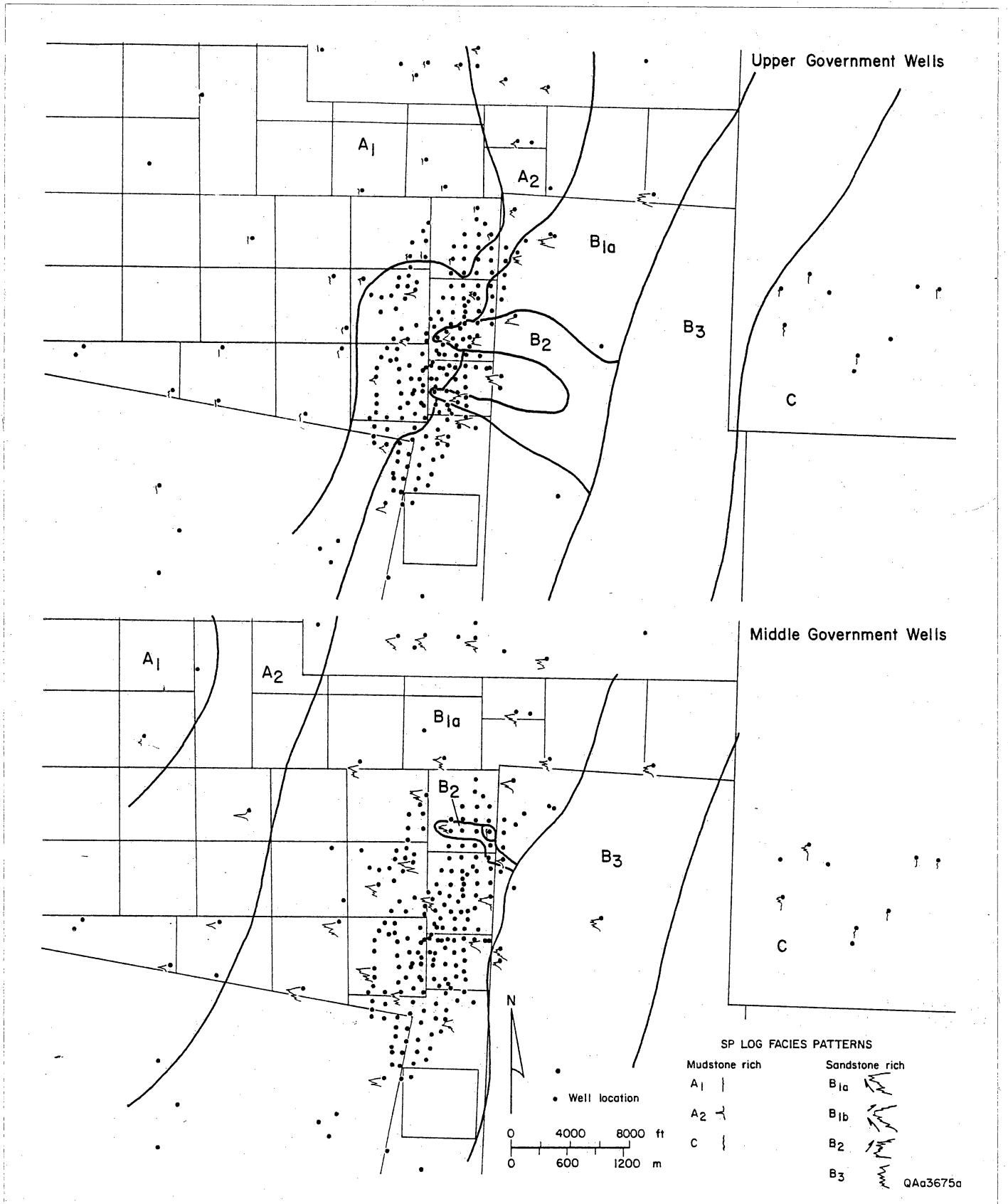
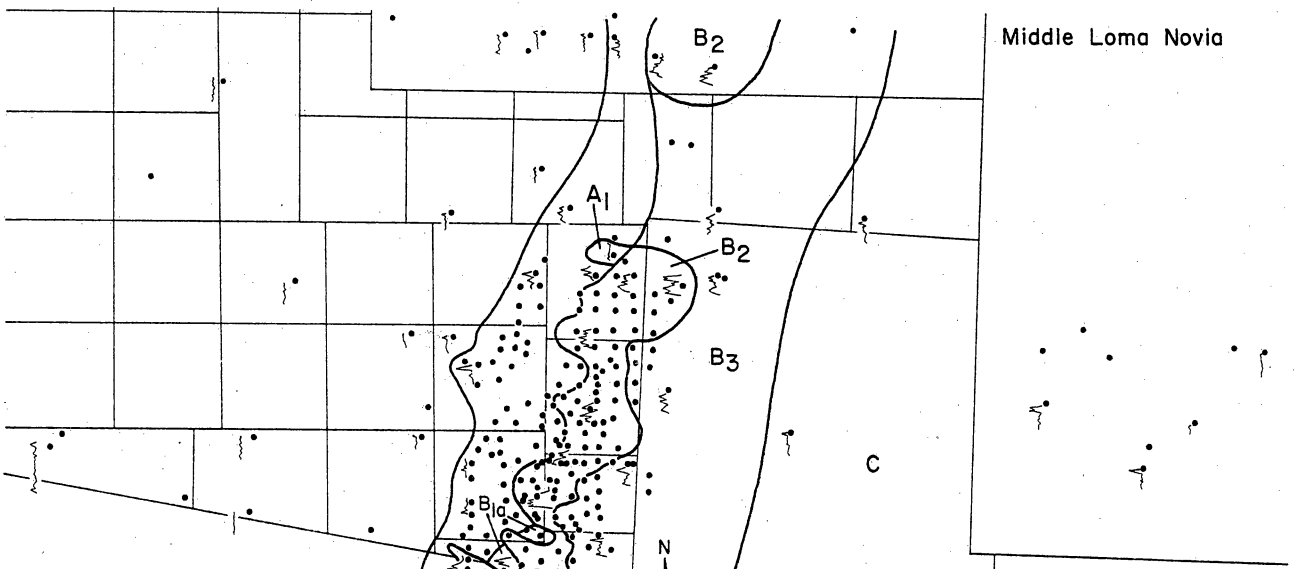
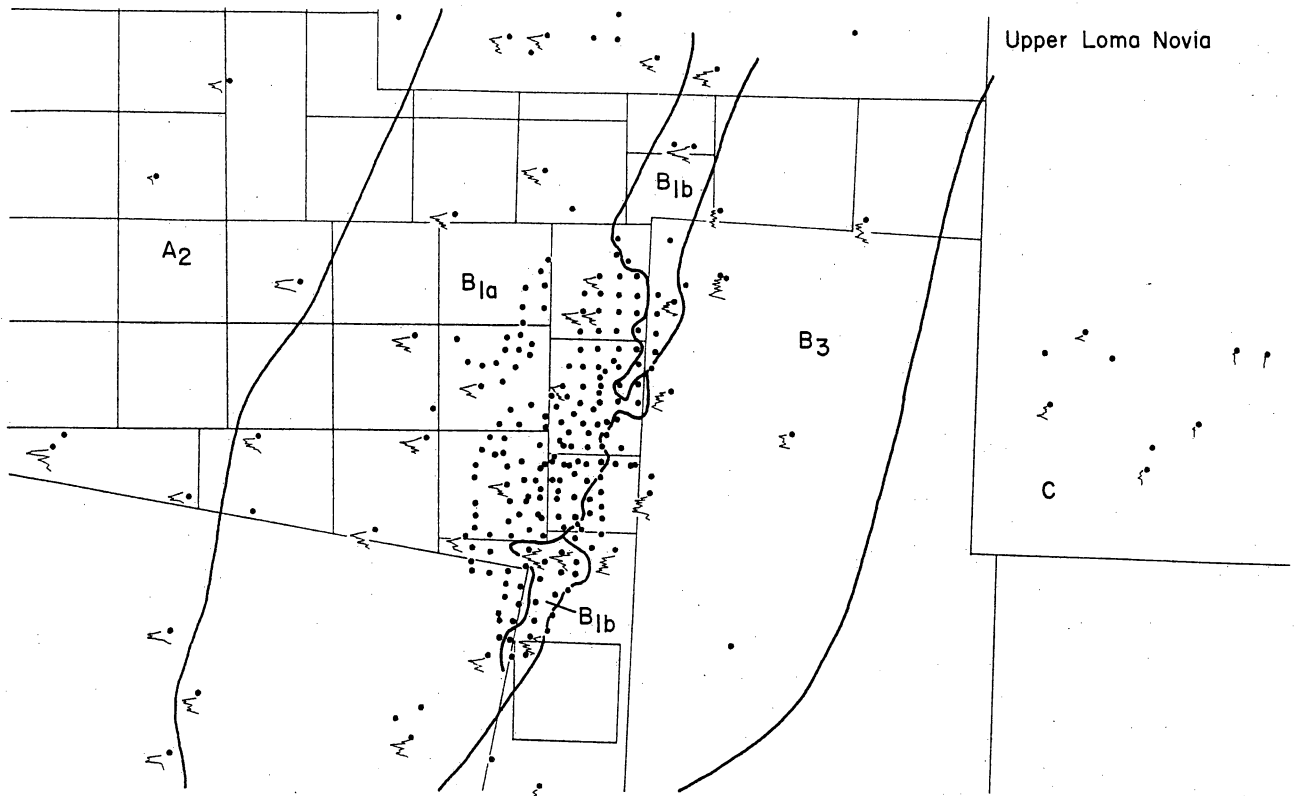
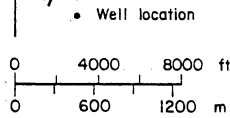


Figure 16. SP log facies of Upper Government Wells, Middle Government Wells, Upper Loma Novia, and Middle Loma Novia reservoir sandstones, Prado field.



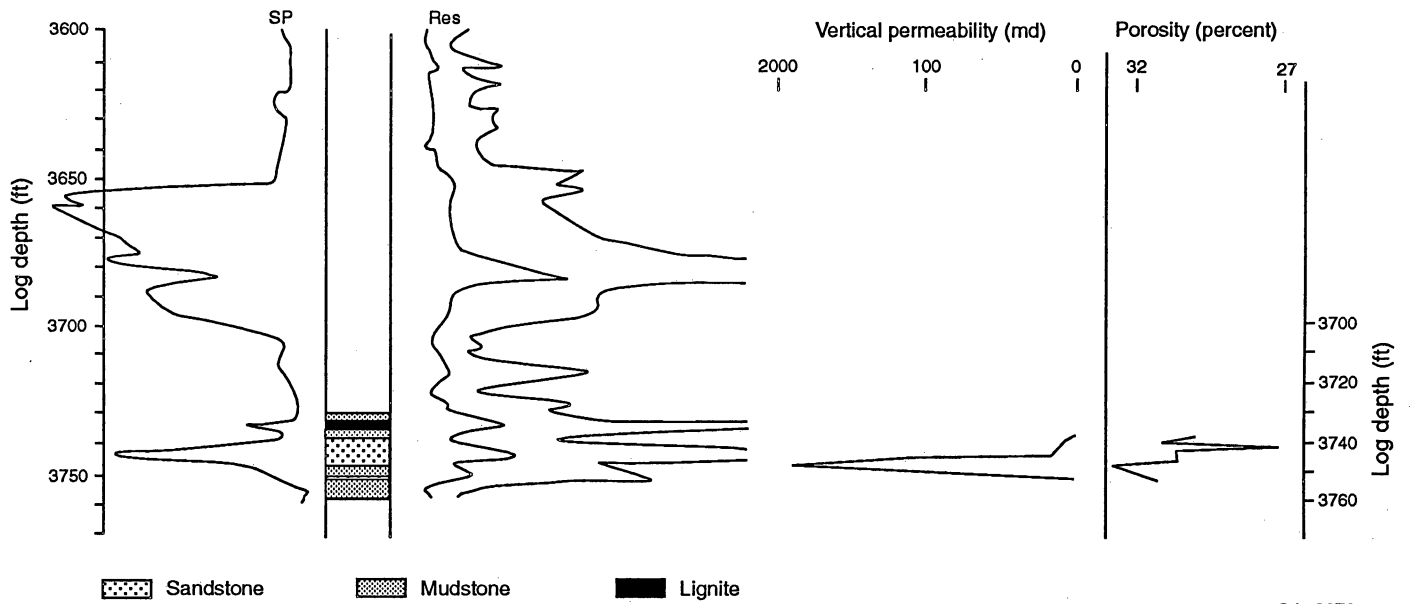
SP LOG FACIES PATTERNS

Mudstone rich	Sandstone rich
A <sub>1</sub>	B <sub>1a</sub>
A <sub>2</sub>	B <sub>1b</sub>
C	B <sub>2</sub>
	B <sub>3</sub>



QAa3675b

Figure 16 continued.



QAa3676c

Figure 17. Detailed electric log and lithologic description of reservoir interval indicating thin back-barrier sandstone overlain by lignite. Porosity and permeability reveal a general upward decrease.

the base of the sandstone. Facies A2 is interpreted to represent mud-rich back-barrier environments where washover sandstones have spilled into the lagoonal environment.

Facies C is also a mudstone-dominated facies that ranges from 100 percent mudstone to mudstone with thin serrate sandstone interbeds. Facies C is located downdip of the sandstone-rich facies and sandstone percentage decreases in a downdip direction. Thin sandstone interbeds in facies C is concentrated in thin serrate bodies with more subdued SP deflection than the spikey sandstone common in facies A. Facies C is interpreted to represent shelf mudstones and thin, interbedded shelf sandstones. The subdued SP response of the shelf sandstones is inferred to indicate their relatively high mudstone content as a result of bioturbation.

The sandstone-rich facies B comprise three subfacies: facies B1—widespread, sheet-like upward-coarsening sandstone, of relatively uniform thickness; facies B2—complex upward-coarsening and upward-fining sand bodies; and facies B3—mixed serrate mudstone and sandstone. Facies B1 tends to be relatively widely distributed in a dip and strike direction, yet it still clearly grades into mudstone both updip and downdip. Facies B1a is capped by an abrupt transition into mudstone, whereas facies B1b is capped by a gradational upward-fining pattern. Facies B1a is inferred to represent a broad barrier bar of relatively homogeneous facies composition. Facies B1b is inferred to represent a flank facies of the barrier bar that was transgressed during relative sea-level rise.

Facies B2 occurs in a narrow, strike-oriented belt containing complex serrate sandstone bodies that typically comprise a lower upward-coarsening sandstone, and an upper upward-fining series of sandstones cut into upward-coarsening sand bodies. Facies B2 includes multiple, upward-fining, erosive-based, channel sand bodies that cut irregularly into the shoreface and barrier sandstones. Facies B2 exhibits rapid lateral facies change into fine-grained facies in both an updip and downdip direction. Facies B2 is inferred to represent a tidally dominated segment of a barrier bar. Subregional correlations of the sand bodies outside the field area demonstrate that facies B1 and B2 are laterally equivalent. Thus, facies B2 apparently represents a reach along a barrier bar chain where tidal inlet fill facies mark the transition between individual barrier bar segments.

Facies B3 is a mixed sandstone and mudstone facies located shelfward of the proximal, sandstone-rich facies of the barrier core B1 and B2. Facies B3 is characterized by serrate upward-coarsening to somewhat blocky SP patterns containing multiple mudstone interbeds. This proximal serrate pattern represents a mixed sandstone/mudstone facies located in parallel and along strike with the barrier core but downdip of the axes of maximum sandstone accumulation. The proximal serrate sandy facies was not dip oriented, and thus was not interpreted as a tidal facies. Instead the proximal serrate sandy facies was interpreted as a proximal shoreface to lower shoreface facies.

#### Unsegmented Barrier-Bar Reservoir Model

The unsegmented barrier-bar sandstone sequence is characterized by shale-encased sand bodies that coarsen upward in grain size and in thickness of bed sets. Middle Government Wells, and Upper Loma Novia reservoirs are all characterized by this relatively homogeneous depositional facies (figs. 8 and 9). The barrier-bar trend of the two reservoir sandstones is 8 to 15 mi wide, as defined by the location of the updip and downdip pinchout position (fig. 14). The similarity of SP log patterns among these barrier-bar sandstones indicates gross parallels in the depositional facies of the two reservoirs (fig. 18). The underlying mudstone-rich shelf facies are gradationally overlain by sandstones that coarsen upward and typically are abruptly overlain by lignite-bearing lagoonal mudstones. The sand-rich facies are rarely segmented by dip-oriented crossing facies, such as tidal inlet channel fill. Barrier-core facies contain the highest percentage sandstone and are characterized by blocky upward-coarsening SP profile. Mudstone-rich facies occur both updip and downdip of the barrier-bar facies. Shelf facies C are mudstone rich and comprise local thin muddy sandstones with suppressed SP patterns as a result of intercalated mudstone. Lagoonal facies are also mudstone rich. Proximal lagoonal facies contain thin spikey to blocky sandstones that are characteristically cleaner with longer SP deflections than equivalent thin sandstones in shelf facies. Presumably the cleaner sandstones in the lagoonal setting reflect higher energy input of sand during washover events and less post-depositional reworking by a low diversity fauna. Although the updip transition into sand-rich back-barrier facies is relatively broad, nonetheless back barrier facies

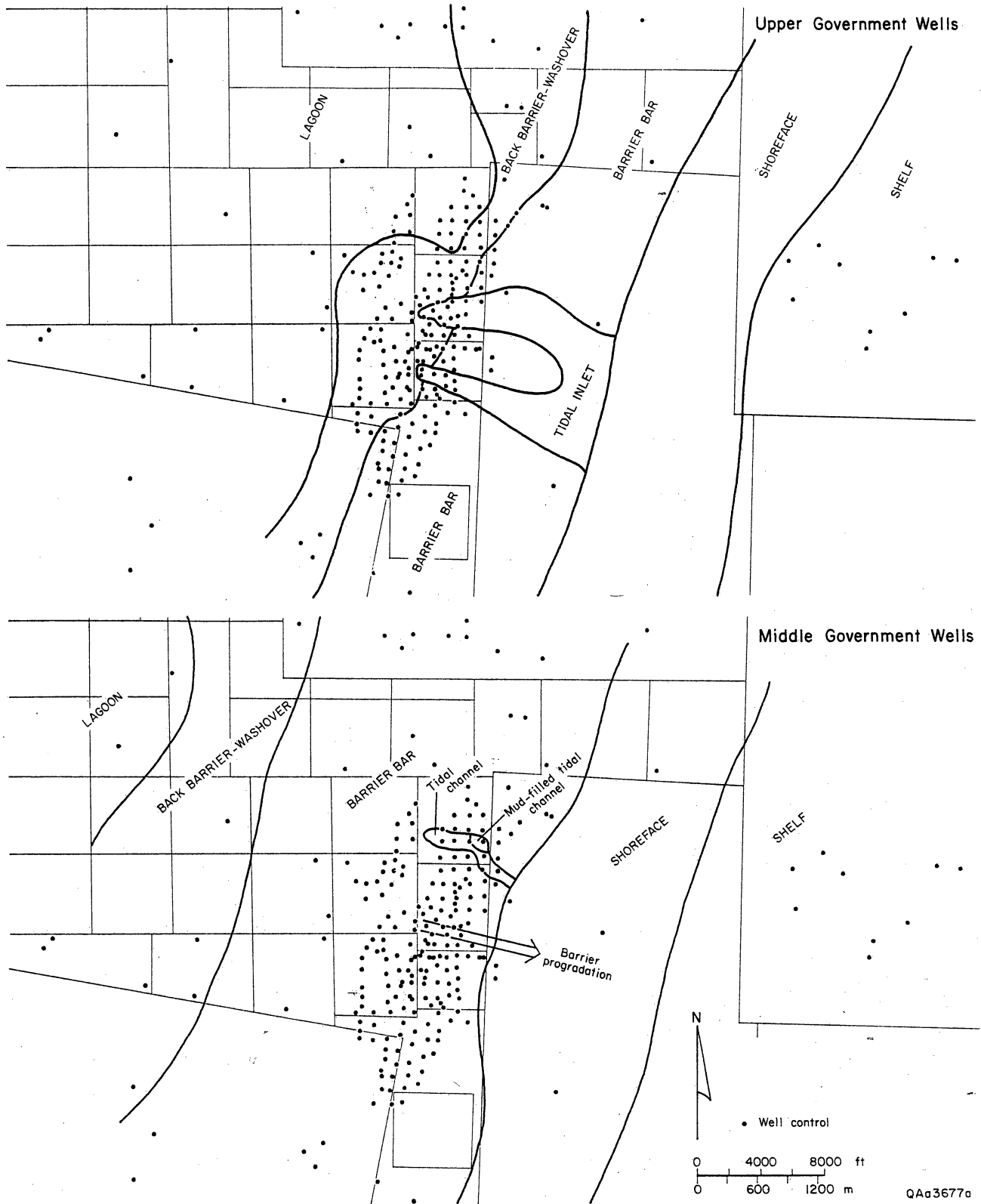
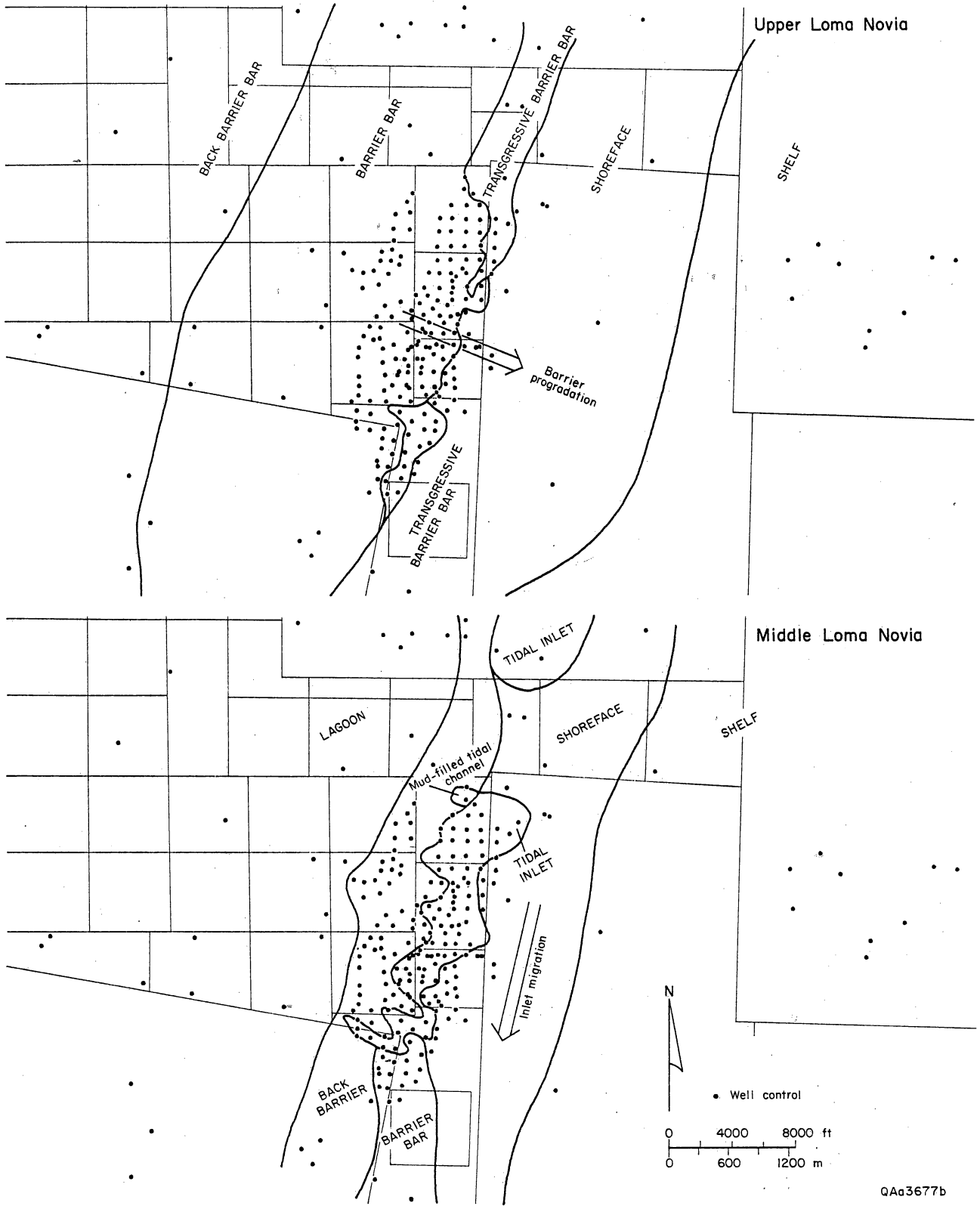


Figure 18. Depositional facies of Upper Government Wells, Middle Government Wells, Upper Loma Novia, and Middle Loma Novia reservoir sandstones, Prado field.



QAa3677b

Figure 18 continued.



do grade into lignitic mudstones. The mudstones of the unsegmented barrier bar do appear to be somewhat sandier in the Middle Government Wells and Upper Loma Novia than equivalent lagoonal mudstones of the Upper Government Wells or the Middle Loma Novia. The positioning of updip lagoonal facies clearly identifies the sand-rich facies as barrier bars and not as sand-rich strandplains.

The upward-coarsening profile is either smooth or serrate, with multiple thinly interbedded mudstones depending on position within the facies tract. A dip-oriented structural cross section shows the log characteristics of the unsegmented barrier-bar reservoir model for the Upper Loma Novia (fig. 19). The cross section also illustrates the contrast in lateral continuity between the unsegmented barrier-bar reservoir model and the tidal-inlet fill reservoir model that characterized the underlying Middle Loma Novia. The Upper Loma Novia and the Middle Government Wells sand bodies are characterized by two separate sandstones in the updip position that are separated by a shale interval (fig. 16). The unsegmented barrier bar models are typically overlain abruptly by lignitic lagoonal mudstone. The Upper Government Wells and Middle Government Wells sand bodies show this pattern very consistently (fig. 16). Locally along the downdip margin of the barrier-bar axis, the upper Upper Loma Novia upward-fining barrier bar is replaced gradationally by an upward-fining sandstone that represents a transgressive barrier bar (fig. 19). The transgressive barrier was established on the southern and northern margins of Prado field, where barrier sands were originally thinner. The characteristic thin bed sets and absence of cut and fill indicate that tidal channel and inlet migration were minor.

The relatively homogeneous facies mosaic of the unsegmented barrier-bar reservoirs places greater emphasis on the structural component for a trapping mechanism. Sandstone-rich facies are spread widely both laterally and along strike. Scour and fill structures that cut across depositional strike, such as tidal or inlet channels, are generally lacking. The absence of migration barriers in the form of facies heterogeneities reduces the probability of identifying facies-controlled compartments in the unsegmented barrier-bar model. Permeability barriers should exist in those segments of the barrier bar that developed transgressed barrier facies containing intercalated mudstone and reservoir sandstone. Such facies occur along the downdip margin of the barrier core in the northern and southern margins of the field.

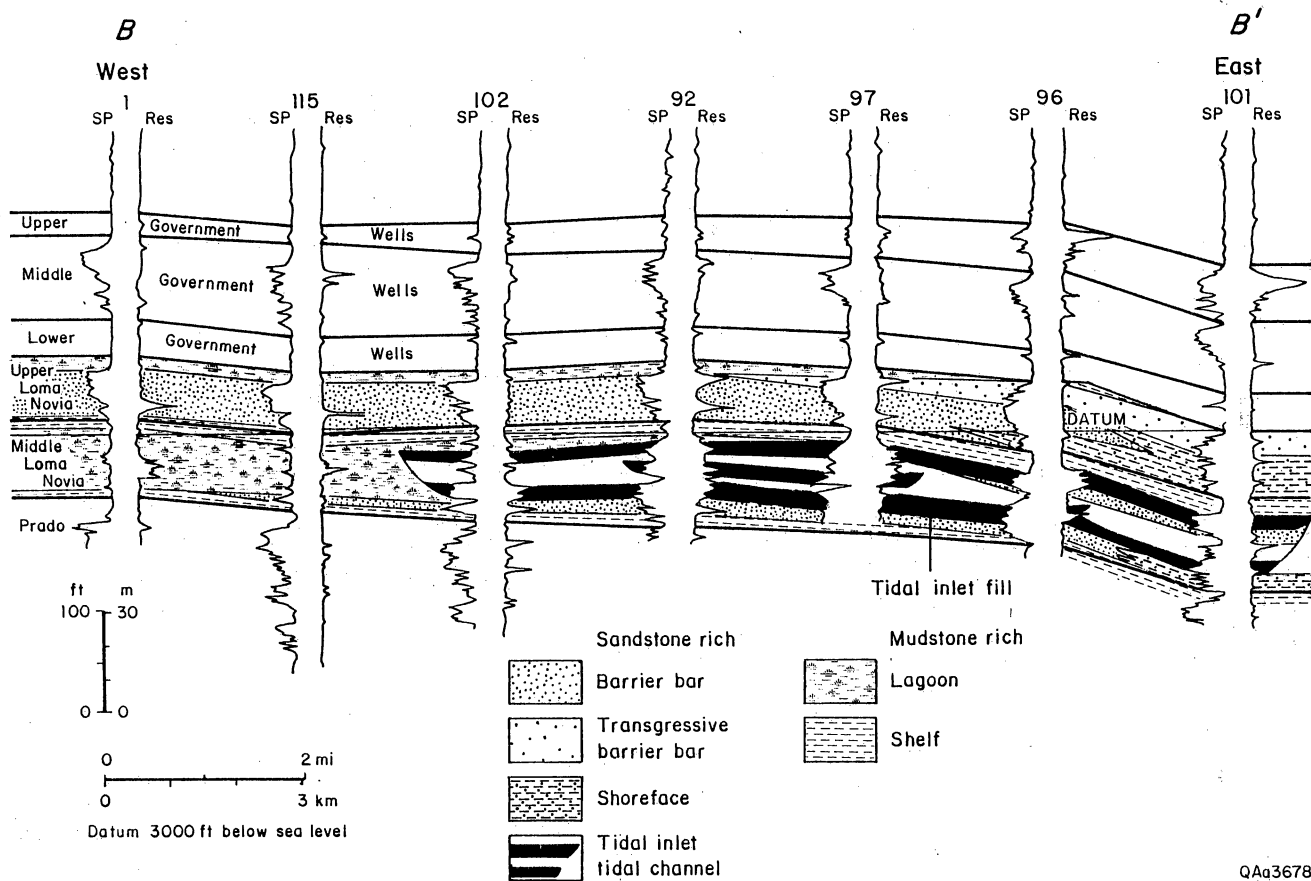


Figure 19. Structural cross section, Prado field, contrasting differing styles of sand-body architecture for barrier-bar facies in Upper Loma Novia reservoir sandstones and tidal-inlet fill in Middle Loma Novia reservoir sandstones.

## Tidal Channel-Inlet Fill Reservoir Model

The irregular thickness and distribution of Middle Loma Novia and Prado reservoir sandstones sharply contrast with the uniform thickness and percentage sandstone of the overlying Upper Loma Novia and Government Wells sandstones (fig. 19). The sandstone-rich facies of the Middle Loma Novia are characterized by abundant, upward-fining channel systems that are laterally discontinuous. In contrast, the overlying Upper Loma Novia contains little evidence of the cut-and-fill processes across the area of the barrier core. The tidal channels clearly pinch out both updip and downdip and thus are not a part of a fluvial-channel system (fig. 16). The facies of the Middle Loma Novia comprise a complex mosaic of environments as a result of variations in the depth and extent of tidal scour (fig. 18). In the southern part of Prado field, barrier-bar facies are preserved below the tidal inlet fill facies. In the central and northern part of the field, tidal cut and fill apparently scoured below the depth of the barrier bar.

The thickness of individual tidal channels ranged from 5 to 40 ft. Lateral connectivity of individual channels is difficult to identify unambiguously. Individual channels apparently are on the order of 500 to 1,000 ft wide and extend updip less than 1 mi. The Middle Loma Novia contains at least three tidal channel/inlet fill sequences (fig. 19) that cut irregularly into upward-coarsening barrier-bar sandstones.

The lateral extent in a dip direction of sand-rich reservoir facies is narrower in the tidal channel-inlet fill model than in the overlying unsegmented barrier bar model. The thickness of individual tidal channels and the thickness of nests of tidal channels decreases toward the south. The direction of tidal channel migration is inferred to have been toward the south.

Sandstone and mudstone are intercalated within the tidal channel-inlet fill system. Although most channels are sandy, some channels are locally mud filled. Mudstone interbeds and numerous cut-and-fill structures combine to yield a complex facies mosaic that contains abundant permeability barriers and heterogeneities. The complex distribution of channel sandstones increases the probability that these facies heterogeneities could have formed favorable compartments that have been poorly drained of their original hydrocarbons to date.

## DISCUSSION

All sand bodies in the Prado field area display an updip and downdip termination, although the width of the belt across which sandstone is preserved varies from 5 to 15 mi. Similar assemblages of facies types also characterize each sandstone sequence. Facies mosaics can be complex within individual sand bodies. Fieldwide SP log facies mapping reveals the absence of fluvial facies characterized by dip-oriented upward-coarsening sandstone packages that connect with and supply sand to the shore-parallel sand bodies. This absence is interpreted to indicate the lack of major dip-oriented fluvial feeder systems. The distribution of seaward-stepping parasequence sets that make up the sand bodies of Prado field must have a primary source of strike-fed sediment predominantly from the north. Widespread subregional mapping has identified isolated upward-coarsening fluvial sand bodies associated with a possible unconformity far updip of the Prado field (fig. 7). A base-level lowering may have originally established the lower Jackson sandstones in the Prado field area by a forced regression from their former position 15 mi updip.

Typically, there was little evidence from regional and fieldwide electric logs useful for distinguishing between lagoonal and shelf mudstone or for identifying an unconformity between the two facies. However, where present, lagoonal lignites characterized by low SP and high resistivity are useful indicators of lagoonal facies. Rare descriptive logs within Prado field have identified lignites overlying back-barrier sandstones. According to Kaiser (1974) and Kaiser and others (1980), such lagoonal lignites are common in the lower Jackson of South Texas and are developed near the tops of barrier/strandplain sandstones. The stratigraphic position of mudstones was used as a correlation guide, and low-resistivity zones within the mudstones provided useful correlation markers. Mudstones updip and behind the barrier/strandplain sandstones were interpreted to be predominantly lagoonal mudstones. For instance, thick progradational barrier-core sandstones are typically overlain by uniform, relatively thick mudstones. The basal portions of these mudstones probably represent lagoonal facies that continued the progradational pattern of the underlying sandstone sequence. The upper portion of the mudstones must represent shelf mudstones as a result of rapid relative sea-level rise in order for the overlying sandstone

sequence to reinitiate a progradational parasequence set. The repetitive nature of stacked progradational parasequence sets indicates that shelf facies must underlie each parasequence set.

The two reservoir models identified at Prado field—unsegmented barrier bar and tidal inlet fill—provide useful criteria for identifying potential for reexploration for bypassed hydrocarbon-bearing compartments. The unsegmented barrier bar model is characterized by a uniform facies mosaic and by a general absence of internal heterogeneities that might provide barriers to hydrocarbon migration. In contrast, the tidal inlet fill model is characterized by abundant heterogeneities that could provide multiple opportunities for lateral and vertical barriers to hydrocarbon migration. The dip orientation of highly permeable tidal channels within the tidal inlet fill model also provides conduits for preferential channeling of water injected into the reservoir for pressure maintenance. Favorable sites for reexploration occur in the Middle Loma Novia where net- and percent-sandstone maps reveal updip-directed thick sandstones that may be related to tidal channel axes and resultant updip flood delta deposits. Such areas may have been incompletely drained as a result of lateral isolation from tidal scour or from mud drapes within tidal channels. Similarly, downdip sandstone thicks resulting from ebb deltas may be appropriate reservoirs; however, the low structural position of the ebb delta may cause the reservoir to be water wet.

## CONCLUSIONS

1. Lower Jackson Group reservoirs have produced 23 million bbl and 32 million mcf gas from barrier-bar depositional systems at Prado field, Jim Hogg County, South Texas. An extensive pressure maintenance program during the 1970's failed to halt the steep decline in production. Fieldwide oil production declined to less than 5,000 bbl/yr in the late 1980's. Recovery efficiency was 34 percent for oil and 69 percent for gas. The relatively low recovery efficiency has prompted efforts at field reexploration.

2. The four primary sand-body reservoirs at Prado field are Prado, Middle Loma Novia, Upper Loma Novia, and Upper Government Wells. The Upper Government Wells is the primary gas reservoir and the Middle Loma Novia is the primary oil reservoir. Sand-body architecture of individual reservoirs ranges from relatively simple to complex. Two reservoirs models describe the end-members of reservoir

complexity at Prado field: (1) the tidal channel inlet fill model and (2) the unsegmented barrier-bar model. The older Prado and Middle Loma Novia sand bodies are complex arrangements sand-rich depositional environments including tidal channel inlet fill, barrier-bar core, back barrier, and shoreface. The tidal channel inlet fill reservoir model describes the primary reservoir environment of the Prado and Middle Loma Novia reservoirs. The younger Upper Loma Novia and Government Wells reservoirs sand bodies comprise a much simpler array of sand-rich depositional environments dominated by a progradational and widespread barrier-bar core, back barrier, and shoreface. The unsegmented barrier-bar model describes the primary reservoir environment of the Upper Loma Novia and Middle Government Wells reservoirs.

3. Lower Jackson Group sandstones reflect an abrupt basinward shift in their initial shoreline position (Prado time) of approximately 15 mi as a result of forced regression during relative base-level lowering. Subsequently oscillations of the shoreline resulted in the net progradation of 2 mi of the shoreline through the Upper Government Wells.

4. Reexploration for additional hydrocarbon resources should concentrate in the complex and positionally heterogeneous environments described in the tidal inlet fill reservoir model. Tidal channel environments comprise complex cut-and-fill processes associated with tidal inlet migration and ebb/flood delta deposition. Barrier core environments might retain untapped reservoir compartments lateral to mud-filled tidal inlet fills. The poor performance of the pressure maintenance program at Prado field underscores the critical importance of understanding reservoir heterogeneities prior to implementation of secondary or tertiary recovery operations.

#### ACKNOWLEDGMENTS

This work was supported by the U.S. Department of Energy and managed through Idaho National Engineering Laboratory Geopressured-Geothermal Program. The authors thank the following individuals and organizations for their assistance; Mark Miller, Petroleum Engineering Department, The University of Texas at Austin; Ray Fortuna, U.S. Department of Energy, Washington, D.C.; Mike Shook and

Jane Negus-de Wys, Idaho National Engineering Laboratory; Charles Kimmell, Fanion Production Company; and Shell Exploration and Production Company. Technical editing was by Tucker F. Hentz. Drafting of the figures was supervised by Richard L. Dillon. Word processing was by Diane Ruetz, editing was by Amanda R. Masterson, and publication design was by Jamie H. Coggin.

## REFERENCES

- Eargle, D. H., 1959, Stratigraphy of Jackson Group (Eocene), south-central Texas: American Association of Petroleum Geologists Bulletin, v. 43, no. 11, p. 2623-2635.
- Fisher, W. L., and McGowen, J. H., 1969, Depositional systems in the Wilcox Group (Eocene) of Texas and their relationship to occurrence of oil and gas: American Association of Petroleum Geologists Bulletin, v. 53, no. 1, p. 30-54.
- Fisher, W. L., Proctor, C. V., Jr., Galloway, W. E., and Nagle, J. S., 1970, Depositional systems in the Jackson Group of Texas—their relationship to oil, gas, and uranium: Gulf Coast Association of Geological Societies Transactions, v. 20, p. 234-261.
- Galloway, W. E., 1989, Genetic stratigraphic sequences in basin analysis I: architecture and genesis of flooding-surface bounded depositional units: American Association of Petroleum Geologists Bulletin, v. 73, no. 2, p. 125-142.
- Galloway, W. E., Hobday, D. K., and Magara, K., 1982, Frio Formation of the Texas Gulf Coast basin: depositional systems, structural framework, and hydrocarbon origin, migration, distribution, and exploration potential: The University of Texas at Austin, Bureau of Economic Geology Report of Investigations No. 122, 78 p.
- Galloway, W. E., Ewing, T. E., Garrett, C. M., Tyler, Noel, and Bebout, D. G., 1983, Atlas of major Texas oil reservoirs: The University of Texas at Austin, Bureau of Economic Geology Special Publication, 139 p.
- Galloway, W. E., Jirik, L. A., Morton, R. A., and DuBar, J. R., 1986, Lower Miocene (Fleming) depositional episode of the Texas coastal plain and continental shelf: structural framework, facies, and hydrocarbon resources: The University of Texas at Austin, Bureau of Economic Geology Report of Investigations No. 150, 50 p.
- Galloway, W. E., and Cheng, E. S.-S., 1985, Reservoir facies architecture in a microtidal barrier system—Frio Formation, Texas Gulf Coast: The University of Texas at Austin, Bureau of Economic Geology Report of Investigations No. 144, 36 p.
- Hamilton, D. S., in press, Potential for increased oil recovery from barrier/strandplain reservoirs of the Jackson-Yegua trend by geologically targeted infill drilling: examples from Seventy-Six West and Colmena-Cedro Hill fields, South Texas: The University of Texas at Austin, Bureau of Economic Geology Report of Investigations.
- Hyatt, D. B., 1990, Geology and production characteristics of the Seventy-Six West field, Duval County, Texas: Gulf Coast Association of Geological Societies Transactions, v. 40, p. 305-318.
- Kaiser, W. R., 1974, Texas lignite: near-surface and deep-basin resources: The University of Texas at Austin, Bureau of Economic Geology Report of Investigations No. 79, 70 p.
- Kaiser, W. R., Ayers, W. B., Jr., and La Brie, L. W., 1980, Lignite resources in Texas: The University of Texas at Austin, Bureau of Economic Geology Report of Investigations No. 104, 52 p.
- Krueger, W. C., Jr., 1968, Depositional environments of sandstones as interpreted from electrical measurements—an introduction: Gulf Coast Association of Geological Societies Transactions, v. 18, p. 226-241.



- Murray, G. E., and Wilbert, L. J., Jr., 1950, Jacksonian stage: American Association of Petroleum Geologists Bulletin, v. 34, no. 10, p. 1990-1997.
- Ramos, A., and Galloway, W. E., 1990, Facies and sand-body geometry of the Queen City (Eocene) tide-dominated delta-margin embayment, NW Gulf of Mexico basin: *Sedimentology*, v. 37, p. 1079-1098.
- Schultz, A. L., 1986, Geology of the first Mirando Sand, South Lopez Unit, Lopez field, Webb and Duval Counties, Texas, *in* Stapp, W. L., ed., Contributions to the geology of South Texas: San Antonio, South Texas Geological Society, p. 100-108.
- Sellards, E. H., Adkins, W. S., and Plummer, F. B., 1932, The geology of Texas: volume 1: stratigraphy: The University of Texas at Austin, Bureau of Economic Geology Publication 3232, 1007 p.
- Seni, S. J., and Walter, T., in press, Geothermal and heavy-oil resources in Texas with emphasis on direct use of geothermal fluid for enhanced recovery of heavy oil: The University of Texas at Austin, Bureau of Economic Geology Geological Circular.
- Tyler, Noel, and Ambrose, W. A., 1985, Facies architecture and production characteristics of strandplain reservoirs in the Frio Formation, Texas: The University of Texas at Austin, Bureau of Economic Geology Report of Investigations No. 146, 42 p.
- \_\_\_\_\_ 1986, Depositional systems and oil and gas plays in the Cretaceous Olmos Formation, South Texas: The University of Texas at Austin, Bureau of Economic Geology Report of Investigations No. 152, 42 p.
- Tyler, Noel, Gholston, J. C., and Ambrose, W. A., 1986, Genetic stratigraphy and oil recovery in an upper Cretaceous wave-dominated deltaic reservoir, Big Wells (San Miguel) field, South Texas: The University of Texas at Austin, Bureau of Economic Geology Report of Investigations No. 153, 38 p.
- West, T. S., Jr., 1963, Typical stratigraphic traps, Jackson trend of South Texas: Gulf Coast Association of Geological Societies Transactions, v. 13, p. 67-78.

Appendix 1. Well log list.

ID	Company	Lease and Number
001	Gorman, Gierhart and Howe	S. K. East No. 4
002	Gorman, Gierhart and Howe	S. K. East No. 40
003	Gorman, Gierhart and Howe	S. K. East No. 1
004	Gorman, Gierhart and Howe	S. K. East No. 14
005	Gorman, Gierhart and Howe	S. K. East No. 5
006	Gorman, Gierhart and Howe	S. K. East No. 3
007	Gorman, Gierhart and Howe	S. K. East No. 2
008	Sun Oil Co.	S. K. East No. 1-C
009	F. P. Schwab et al.	J. H. Allen No. 2
010	La Gloria Co.	S. K. East No. 1
011	La Gloria Co.	S. K. East No. 2
012	Prado Oil and Gas Co.	S. K. East No. 311
013	Gorman, Gierhart and Howe	S. K. East No. B-2
014	Gorman, Gierhart and Howe	S. K. East No. E-3
015	Prado Oil and Gas Co.	S. K. East No. 164
016	Sun Oil Co.	S. K. East No. 3
017	Blair-Vreeland	J. H. Allen No. 1
018	La Gloria Co.	S. K. East No. 3
019	Prado Oil and Gas Co.	S. K. East No. 301
020	Gorman, Gierhart and Howe	S. K. East No. E-1
021	Prado Oil and Gas Co.	S. K. East No. 55
022	Prado Oil and Gas Co.	S. K. East No. 66
023	Prado Oil and Gas Co.	S. K. East No. 78
024	Sohio Petroleum Co.	S. K. East No. 429
025	Gorman, Gierhart and Howe	S. K. East No. C-1
040	Joseph S. Morris et al.	Mestena No. 2
041	Joseph S. Morris et al.	Mestena No. 3
042	Joseph S. Morris et al.	Mestena No. 4
043	Joseph S. Morris et al.	Mestena No. 5
044	CPC Exploration	Mestena No. 2
045	Joseph S. Morris et al.	Mestena No. 7
046	Joseph S. Morris et al.	Mestena No. 6
047	H. M. Howell	Mestena No. 1
048	Joseph S. Morris et al.	Mestena No. 1
049	Jake L. Hamon	Reynaldo Saenz G U No. 1
050	Carter Exploration Co.	Reynaldo Saenz No. 1
051	CPC Exploration	Mestena No. 1
052	Humble Oil and Refining	Mrs. A. K. East No. 1
053	Stroube Prod.-Hill Prod.	Mestena No. 1
054	Humble Oil and Refining	Mrs. A. K. East No. 3
055	Humble Oil and Refining	Mrs. A. K. East No. 2
056	Alta Vista Exploration Inc.	Loma No. 1
057	Humble	Canales No. 1
058	Patrick Petroleum Co.	Frankie Armstrong No. 1
059	Topp Petroleum Co.	Canales Heirs No. 1
060	Prado Oil and Gas Co.	S. K. East No. 93
061	Prado Oil and Gas Co.	S. K. East No. 95
062	Gorman, Gierhart and Howe	S. K. East No. 7

## Appendix 1 (cont.)

ID	Company	Lease and Number
063	Gorman, Gierhart and Howe	S. K. East No. 6
064	Gorman, Gierhart and Howe	S. K. East No. 8
065	Gorman, Gierhart and Howe	S. K. East No. 10
066	Gorman, Gierhart and Howe	S. K. East No. 11
067	Gorman, Gierhart and Howe	S. K. East No. 12
068	Gorman, Gierhart and Howe	S. K. East No. 13
069	Prado Oil and Gas Co.	S. K. East No. 59
070	Prado Oil and Gas Co.	S. K. East No. 60
071	Prado Oil and Gas Co.	S. K. East No. 68
072	Prado Oil and Gas Co.	S. K. East No. 71
073	Prado Oil and Gas Co.	S. K. East No. 72
074	Standard Oil Prod. Co.	S. K. East No. A-501
075	Prado Oil and Gas Co.	S. K. East No. 70
076	Prado Oil and Gas Co.	S. K. East No. 69
077	Gorman, Gierhart and Howe	S. K. East No. 9
078	Sun Oil Co.	S. K. East No. 4
079	Alta Vista Exploration Co.	Arroya-Baluarto No. 1
080	Miller Bros. & Bowling	J. M. Tygart No. 1
081	The Texas Co.	E. L. Armstrong No. 1
090	Gorman, Geirhart and Howe	S. K. East No. 16
091	Gorman, Gierhart and Howe	S. K. East No. 19
092	Gorman, Gierhart and Howe	S. K. East No. 20
093	Gorman, Gierhart and Howe	S. K. East No. 24
094	Gorman, Gierhart and Howe	S. K. East No. 25
095	Gorman, Gierhart and Howe	S. K. East No. 26
096	Gorman, Gierhart and Howe	S. K. East No. 27
097	Gorman, Gierhart and Howe	S. K. East No. 29
098	Gorman, Gierhart and Howe	S. K. East No. 36
099	Gorman, Gierhart and Howe	S. K. East No. 52
100	Gorman, Gierhart and Howe	S. K. East No. 53
101	Gorman, Gierhart and Howe	S. K. East No. 54
102	Gorman, Gierhart and Howe	S. K. East No. 67
103	Gorman, Gierhart and Howe	S. K. East No. 74
104	Gorman, Gierhart and Howe	S. K. East No. 75
105	Gorman, Gierhart and Howe	S. K. East No. 77
106	Gorman, Gierhart and Howe	S. K. East No. 89
107	Gorman, Gierhart and Howe	S. K. East No. 91
108	Gorman, Gierhart and Howe	S. K. East No. 208
109	Gorman, Gierhart and Howe	S. K. East No. 225
110	Sohio Petroleum Co.	S. K. East No. 315
111	Prado Oil and Gas Co.	S. K. East No. 76
112	Gorman, Gierhart and Howe	S. K. East No. 21
113	Gorman, Gierhart and Howe	S. K. East No. 22
114	Prado Oil and Gas Co.	S. K. East No. 79-A
115	Prado Oil and Gas Co.	S. K. East No. 90
116	Prado Oil and Gas Co.	S. K. East No. 78
117	L. H. Haring Jr.	Well Brothers A-1
118	Philip L. Davidson	Well Brothers No. 1

Appendix 1 (cont.)

ID	Company	Lease and Number
119	M. L. Massingill et al.	Howel McCampbell No. 1
120	Gorman, Gierhart and Howe	S. K. East No. 15
121	Gorman, Gierhart and Howe	S. K. East No. 23
122	Gorman, Gierhart and Howe	S. K. East No. 30
123	Gorman, Gierhart and Howe	S. K. East No. 33
124	Gorman, Gierhart and Howe	S. K. East No. 34
125	Gorman, Gierhart and Howe	S. K. East No. 35
126	Gorman, Gierhart and Howe	S. K. East No. 37
127	Gorman, Gierhart and Howe	S. K. East No. 38
128	Gorman, Gierhart and Howe	S. K. East No. 41
129	Gorman, Gierhart and Howe	S. K. East No. 42
130	Gorman, Gierhart and Howe	S. K. East No. 43
131	Gorman, Gierhart and Howe	S. K. East No. 44
132	Gorman, Gierhart and Howe	S. K. East No. 45
133	Gorman, Gierhart and Howe	S. K. East No. 46
134	Gorman, Gierhart and Howe	S. K. East No. 47
135	Gorman, Gierhart and Howe	S. K. East No. 48
136	Gorman, Gierhart and Howe	S. K. East No. 49
137	Gorman, Gierhart and Howe	S. K. East No. 50
138	Gorman, Gierhart and Howe	S. K. East No. 51
139	Prado Oil and Gas Co.	S. K. East No. 56
140	Prado Oil and Gas Co.	S. K. East No. 58
141	Prado Oil and Gas Co.	S. K. East No. 61
142	Prado Oil and Gas Co.	S. K. East No. 62
143	Prado Oil and Gas Co.	S. K. East No. 63
144	Prado Oil and Gas Co.	S. K. East No. 64
145	Prado Oil and Gas Co.	S. K. East No. 65
146	Prado Oil and Gas Co.	S. K. East No. 73
147	Prado Oil and Gas Co.	S. K. East No. 80
148	Prado Oil and Gas Co.	S. K. East No. 82
149	Prado Oil and Gas Co.	S. K. East No. 83
150	Prado Oil and Gas Co.	S. K. East No. 84
151	Prado Oil and Gas Co.	S. K. East No. 85
152	Prado Oil and Gas Co.	S. K. East No. 86
153	Prado Oil and Gas Co.	S. K. East No. 87
154	Prado Oil and Gas Co.	S. K. East No. 88
155	Prado Oil and Gas Co.	S. K. East No. 224
156	Prado Oil and Gas Co.	S. K. East No. 81
157	Gorman, Gierhart and Howe	S. K. East No. 18
158	Gorman, Gierhart and Howe	S. K. East No. 31
159	Gorman, Gierhart and Howe	S. K. East No. 17
160	Gorman, Gierhart and Howe	S. K. East No. 32
161	Prado Oil and Gas Co.	S. K. East No. 98
162	Gorman, Gierhart and Howe	S. K. East No. 39
163	Prado Oil and Gas Co.	S. K. East No. 99
164	Prado Oil and Gas Co.	S. K. East No. 96
165	Prado Oil and Gas Co.	S. K. East No. 97
166	Sun Oil Co.	Well Brothers No. 43

## Appendix 1 (cont.)

ID	Company	Lease and Number
167	L. H. Haring Jr.	Mestena No. 1
168	Killam & Hurd	Well et al. No. 1
169	Sun Oil Co.	Mestena No. 2
170	South Texas Oil & Gas Co.	McC Campbell No. 1
171	Main Oil Co.	McC Campbell No. 1
172	Sun Oil Co.	Well Bros. No. 2
173	Sun Oil Co.	Well Bros. No. 3
174	Dyco Petroleum Co.	D. F. McC Campbell No. 1
175	Humble Oil & Refining Co.	Mestena Oil & Gas No. 3-H
176	Humble Oil & Refining Co.	Mestena Oil & Gas No. 3-B
177	Clavo & Hamill	Mestena Oil & Gas No. 1-B
180	Gorman, Gierhart and Howe	S. K. East No. 104
181	Gorman, Gierhart and Howe	S. K. East No. 105
182	Gorman, Gierhart and Howe	S. K. East No. 106
183	Gorman, Gierhart and Howe	S. K. East No. 107
184	Gorman, Gierhart and Howe	S. K. East No. 108
185	Gorman, Gierhart and Howe	S. K. East No. 115
186	Gorman, Gierhart and Howe	S. K. East No. 116
187	Gorman, Gierhart and Howe	S. K. East No. 120
188	Gorman, Gierhart and Howe	S. K. East No. 123
189	Prado Oil and Gas Co.	S. K. East No. 126
190	Prado Oil and Gas Co.	S. K. East No. 127
191	Prado Oil and Gas Co.	S. K. East No. 128
192	Prado Oil and Gas Co.	S. K. East No. 133
193	Prado Oil and Gas Co.	S. K. East No. 138
194	Prado Oil and Gas Co.	S. K. East No. 139
195	Prado Oil and Gas Co.	S. K. East No. 140
196	Prado Oil and Gas Co.	S. K. East No. 141
197	Prado Oil and Gas Co.	S. K. East No. 142
198	Prado Oil and Gas Co.	S. K. East No. 143
199	Prado Oil and Gas Co.	S. K. East No. 144
200	Prado Oil and Gas Co.	S. K. East No. 145
201	Prado Oil and Gas Co.	S. K. East No. 146
202	Prado Oil and Gas Co.	S. K. East No. 147
203	Prado Oil and Gas Co.	S. K. East No. 149
204	Prado Oil and Gas Co.	S. K. East No. 153
205	Prado Oil and Gas Co.	S. K. East No. 184
206	Prado Oil and Gas Co.	S. K. East No. 186
207	Prado Oil and Gas Co.	S. K. East No. 187
208	Prado Oil and Gas Co.	S. K. East No. 188
209	Prado Oil and Gas Co.	S. K. East No. 191
210	Prado Oil and Gas Co.	S. K. East No. 192
211	PI Energy	Kennedy Foundation No. 1-B
230	Gorman, Gierhart and Howe	S. K. East No. 109
231	Gorman, Gierhart and Howe	S. K. East No. 122
232	Gorman, Gierhart and Howe	S. K. East No. 124
233	Prado Oil and Gas Co.	S. K. East No. 134
234	Prado Oil and Gas Co.	S. K. East No. 135

## Appendix 1 (cont.)

ID	Company	Lease and Number
235	Prado Oil and Gas Co.	S. K. East No. 136
236	Prado Oil and Gas Co.	S. K. East No. 137
237	Prado Oil and Gas Co.	S. K. East No. 150
238	Prado Oil and Gas Co.	S. K. East No. 151
239	Prado Oil and Gas Co.	S. K. East No. 152
240	Prado Oil and Gas Co.	S. K. East No. 156
241	Prado Oil and Gas Co.	S. K. East No. 157
242	Prado Oil and Gas Co.	S. K. East No. 158
243	Prado Oil and Gas Co.	S. K. East No. 163
244	Prado Oil and Gas Co.	S. K. East No. 189
245	Prado Oil and Gas Co.	S. K. East No. 190
246	Gorman, Gierhart and Howe	S. K. East No. 202
247	Gorman, Gierhart and Howe	S. K. East No. 203
248	Gorman, Gierhart and Howe	S. K. East No. 204
249	Gorman, Gierhart and Howe	S. K. East No. 207
250	Prado Oil and Gas Co.	S. K. East No. 209
251	Prado Oil and Gas Co.	S. K. East No. 221
252	Sohio Petroleum Co.	S. K. East No. 226
253	Sohio Petroleum Co.	S. K. East No. 227
254	Prado Oil and Gas Co.	S. K. East No. 194
255	Prado Oil and Gas Co.	S. K. East No. 119
256	Prado Oil and Gas Co.	S. K. East No. 110
257	Prado Oil and Gas Co.	S. K. East No. 298
258	Prado Oil and Gas Co.	S. K. East No. 214
259	Prado Oil and Gas Co.	S. K. East No. 195
270	Gorman, Gierhart and Howe	S. K. East No. 111
271	Gorman, Gierhart and Howe	S. K. East No. 112
272	Prado Oil and Gas Co.	S. K. East No. 148
273	Prado Oil and Gas Co.	S. K. East No. 154
274	Prado Oil and Gas Co.	S. K. East No. 155
275	Prado Oil and Gas Co.	S. K. East No. 160
276	Prado Oil and Gas Co.	S. K. East No. 161
277	Prado Oil and Gas Co.	S. K. East No. 162
278	Prado Oil and Gas Co.	S. K. East No. 165
279	Prado Oil and Gas Co.	S. K. East No. 166
280	Prado Oil and Gas Co.	S. K. East No. 168
281	Prado Oil and Gas Co.	S. K. East No. 169
282	Prado Oil and Gas Co.	S. K. East No. 170
283	Prado Oil and Gas Co.	S. K. East No. 172
284	Prado Oil and Gas Co.	S. K. East No. 175
285	Prado Oil and Gas Co.	S. K. East No. 176
286	Prado Oil and Gas Co.	S. K. East No. 179
287	Prado Oil and Gas Co.	S. K. East No. 211
288	Prado Oil and Gas Co.	S. K. East No. 212
289	Prado Oil and Gas Co.	S. K. East No. 215
290	Prado Oil and Gas Co.	S. K. East No. 216
291	Prado Oil and Gas Co.	S. K. East No. 219
292	Prado Oil and Gas Co.	S. K. East No. 213

## Appendix 1 (cont.)

ID	Company	Lease and Number
293	Prado Oil and Gas Co.	S. K. East No. 222
294	Hughes Texas Petroleum Co.	S. K. East No. C-1
295	Prado Oil and Gas Co.	S. K. East No. 199
296	Prado Oil and Gas Co.	S. K. East No. 174
297	Prado Oil and Gas Co.	S. K. East No. 173
298	Prado Oil and Gas Co.	S. K. East No. 171
299	Prado Oil and Gas Co.	S. K. East No. 159
300	Prado Oil and Gas Co.	S. K. East No. 184
301	Prado Oil and Gas Co.	S. K. East No. 223
302	Gorman, Gierhart and Howe	S. K. East No. B-17
303	Gorman, Gierhart and Howe	S. K. East No. B-1
304	Prado Oil and Gas Co.	S. K. East No. 178
305	Prado Oil and Gas Co.	S. K. East No. 177
306	Prado Oil and Gas Co.	S. K. East No. 181
307	Prado Oil and Gas Co.	S. K. East No. 180
308	Prado Oil and Gas Co.	S. K. East No. 299
309	Prado Oil and Gas Co.	S. K. East No. 217
310	Prado Oil and Gas Co.	S. K. East No. 218
311	Prado Oil and Gas Co.	S. K. East No. 167
312	Prado Oil and Gas Co.	S. K. East No. 113
313	D. A. Hughes Co.	S. K. East No. D-3
314	Hughes Texas Petroleum	East No. 8/6/86
315	Gifford Oil Co.	D. O. Gallagher No. 1-B

Appendix 2. Cross section well list.

A - A'

No.	BEG No.	Operator	Fee
1	37	Shell Oil Co.	No. 1 Bruni & Killam Trust
2	36	Superior Oil Co.	No. 1 Marie McGrath
3	130	Hughes & Hughes	No. 1 "G" L. A. Hinnant
4	2	Atlantic Refining	No. A-1 Stroman-Armstrong
5	8	Jake L. Hamon	No. 1 Reuben Holbein
6	10	Standard Oil Co.	No. 2 Reuben Holbein
7	14	Jake L. Hamon	No. 2 Francisco Perez
8	33	C & K Petroleum	No. 1 Martinez
9	34	Edwin L. Cox & Berry R. Cox	No. 1 A. A. Martinez
10	307	Amerada Petroleum Co.	No. 2 A. A. Martinez
11	313	W. Earl Rowe	No. 1 Martinez
12	59	Topp Petroleum Co.	No. 1 Canales Heirs
13	23	Prado Oil & Gas Co.	No. 78 S. K. East
14	246	Gorman, Gierhart & Howe	No. 202 S. K. East
15	108	Prado Oil & Gas Co.	No. 208 S. K. East
16	168	Killiam & Hurd Ltd.	No. 1 Ruth Well et al.
17	167	Haring	No. 1 Mestena

B - B'

No.	BEG No.	Operator	Fee
4	1	Prado Oil & Gas Co.	No. 4 S. K. East
90	115	Prado Oil & Gas Co.	No. 90 S. K. East
67	102	Prado Oil & Gas Co.	No. 67 S. K. East
20	92	Prado Oil & Gas Co.	No. 20 S. K. East
29	97	Prado Oil & Gas Co.	No. 29 S. K. East
27	96	Prado Oil & Gas Co.	No. 27 S. K. East
54	101	Prado Oil & Gas Co.	No. 54 S. K. East



Appendix 2 (cont.)

C - C'

No.	BEG No.	Operator	Fee
1	285	Prado Oil & Gas Co.	No. 176 S. K. East
2	286	Prado Oil & Gas Co.	No. 179 S. K. East
3	275	Prado Oil & Gas Co.	No. 160 S. K. East
4	272	Prado Oil & Gas Co.	No. 148 S. K. East
5	186	Gorman, Gierhart & Howe	No. B-16 S. K. East
6	192	Prado Oil & Gas Co.	No. 133 S. K. East
7	208	Prado Oil & Gas Co.	No. 188 S. K. East
8	195	Prado Oil & Gas Co.	No. 140 S. K. East
9	244	Prado Oil & Gas Co.	No. 189 S. K. East
10	127	Gorman, Gierhart & Howe	No. 38 S. K. East
11	139	Prado Oil & Gas Co.	No. 56 S. K. East
12	131	Gorman, Gierhart & Howe	No. 44 S. K. East
13	129	Gorman, Gierhart & Howe	No. 42 S. K. East
14	128	Gorman, Gierhart & Howe	No. 41 S. K. East
15	122	Gorman, Gierhart & Howe	No. 30 S. K. East
16	121	Gorman, Gierhart & Howe	No. 23 S. K. East
17	95	Gorman, Gierhart & Howe	No. 26 S. K. East
18	104	Prado Oil & Gas Co.	No. 75 S. K. East
19	102	Prado Oil & Gas Co.	No. 67 S. K. East
20	107	Prado Oil & Gas Co.	No. 91 S. K. East
21	98	Gorman, Gierhart & Howe	No. 36 S. K. East
22	21	Prado Oil & Gas Co.	No. 55 S. K. East

D - D'

No.	BEG No.	Operator	Fee
1	60	Prado Oil & Gas Co.	No. 93 S. K. East
2	65	Gorman, Gierhart & Howe	No. 10 S. K. East
3	68	Gorman, Gierhart & Howe	No. 13 S. K. East
4	72	Prado Oil & Gas Co.	No. 71 S. K. East
5	69	Prado Oil & Gas Co.	No. 59 S. K. East
6	147	Prado Oil & Gas Co.	No. 80 S. K. East
7	127	Gorman, Gierhart & Howe	No. 38 S. K. East
8	156	Prado Oil & Gas Co.	No. 81 S. K. East
9	126	Gorman, Gierhart & Howe	No. 37 S. K. East
10	148	Prado Oil & Gas Co.	No. 82 S. K. East
11	125	Gorman, Gierhart & Howe	No. 35 S. K. East
12	161	Prado Oil & Gas Co.	No. 98 S. K. East
13	253	Sohio Petroleum Co.	No. 227 S. K. East
14	257	Prado Oil & Gas Co.	No. 298 S. K. East
15	251	Prado Oil & Gas Co.	No. 221 S. K. East



*[Faint, illegible handwriting in the top section of the lined area.]*

*[Faint, illegible handwriting in the middle section of the lined area.]*

*[Faint, illegible handwriting in the bottom section of the lined area.]*



## OBJECTIVES

The objective of the Offshore Northern Gulf of Mexico Oil and Gas Resource Atlas Series is to define hydrocarbon plays by integrating geologic and engineering data for oil and gas reservoirs with large-scale patterns of depositional basin fill and geologic age. The primary product of the program will be an oil and gas atlas set for the offshore northern Gulf of Mexico and a computerized geographical information system of geologic and engineering data linked to reservoir location. The oil and gas atlas for the Gulf of Mexico will provide a critically compiled, comprehensive reference that is needed to more efficiently develop reservoirs, to extend field limits, and to better assess the opportunities for intrafield exploration. The play atlas will provide an organizational framework to aid development in mature areas and to extend exploration paradigms from mature areas into frontier areas deep below the shelf and into deep waters of the continental slope. In addition to serving as a model for exploration and education, the offshore atlas will aid resource assessment efforts of State, Federal, and private agencies by allowing for greater precision in the extrapolation of variables within and between plays. Classification and organization of reservoirs into plays have proved to be effective in previous atlases produced by the Bureau, including the Texas oil and gas atlases, the Midcontinent gas atlas, and Central and Eastern Gulf Coast gas atlas.

## BACKGROUND INFORMATION

The Offshore Northern Gulf of Mexico Oil and Gas Resource Atlas Series is a cooperative research effort managed by the Bureau of Economic Geology as lead technical contractor. Funding for the program is supplied by the Department of Energy (DOE) through Morgantown Energy Technology Center (METC) and Bartlesville Program Office (BPO), the Gas Research Institute (GRI), and the Minerals Management Service (MMS). The State of Louisiana Center for Coastal, Energy, and Environmental Resources and the Geological Survey of Alabama are subcontractors for research in their respective State waters.

## PROJECT DESCRIPTION

The four-year program ended its first year in October 1993. The program is divided into three primary tasks: task 1—program management, task 2—Atlas 1, and task 3—Atlas 2. Task 2 represents the work required to complete Atlas 1: Miocene and older plays. Task 3 represents the work required to complete Atlas 1: Plio-Pleistocene plays. During the first year, both tasks 1 and 2 were initiated. Task 3 work is scheduled to begin in 1994.

## RESULTS

### Task 1

Program management efforts include completion of quarterly reports for DOE and monthly milestone reports for GRI as required by the contracts. The process for granting subcontracts to Louisiana and Alabama for work in their respective State waters was implemented. An important milestone under task 1 was establishing an Industrial Technical Advisors Committee (ITAC) that consists of major oil and gas operators active in hydrocarbon exploration and production in the Gulf of Mexico. The following companies agreed to support the Gulf of Mexico atlas through their participation in the ITAC: ARCO Oil and Gas Company; CNG Producing Company; Conoco Inc.; Marathon Oil Company; Oryx Energy Company; Shell Offshore Inc., Exploration Assets; Texaco USA; and Unocal Corporation. On October 12, 1993, the first ITAC meeting was held in Austin, Texas. That meeting was hosted by the Bureau and attended by the funding agencies and the ITAC membership. During that meeting, Bureau representatives gave progress reports on the status of the atlas program, the framework and purpose of the ITAC was finalized, and a procedure for review of plays by the ITAC company staff members was determined.

### Task 2

The primary goal of the atlas program is the integration of critically compiled reservoir data within a reservoir play framework. Compilation of data was the primary research effort during the first year of the contract. Collection of geologic and engineering reservoir data was concluded in the offshore Texas State Lands area. Quality control parameters of collected data, derivation of calculated reservoir volumetrics, and transfer of data into digital computer format are still being performed. Prior to this study, the MMS had previously compiled geologic and reservoir data for the Federal OCS in the FRRE database. During the first year, MMS staff rechecked and reorganized reservoir data in this database to integrate it with the atlas program.

A generalized play analysis procedure was implemented that is tailored specifically to the requirements of the atlas program. The procedure is as follows: (1) define chronozone map unit, (2) outline area of production, (3) collect reservoir engineering and geologic data, (4) identify reservoirs on field type log, (5) correlate productive intervals, biozones, structural style, and depositional facies on strike- and dip-oriented cross sections with type logs for fields, (6) identify and describe type reservoir/field within chronozone map unit, (7) tabulate reservoir engineering data for each reservoir, (8) synthesize defining attributes of each play, (9) outline area of play, and (10) write play description. Defining attributes that characterize specific plays include: (1) chronozone age,

(2) depositional system, (3) structural style, (4) hydrocarbon type, (5) trapping mechanism, (6) hydrocarbon source, (7) exploration maturity, (8) frontiers, and (9) limitations.

**Play Analysis.** Preliminary play analysis of reservoirs in the offshore Texas State Lands and adjacent Federal OCS has identified 34 plays of Miocene and older reservoirs. This identification has concentrated on lower Miocene and Oligocene reservoirs because these plays are located predominantly in State waters. The distribution of Oligocene and lower Miocene plays is illustrated in figure 1. Plays associated with younger middle and upper Miocene reservoirs extend into the Federal OCS and are not shown in figure 1. The following discussion will provide examples of gas-prone plays from the Oligocene Frio–Anahuac and the lower Miocene.

***Oligocene Frio–Anahuac Plays.*** Play analysis of Oligocene Frio–Anahuac reservoirs has almost been completed in the Texas offshore area. All geologic and engineering data have been compiled for Frio–Anahuac fields and reservoirs. In addition, Frio–Anahuac-type fields have been identified, and their geologic and engineering data have been synthesized. Aggregation of data from reservoirs to atlas sand-body reservoirs has also been completed. All Oligocene reservoirs have been located on the type logs, and type logs have been identified for all fields. A typical log shows the productive interval and the relationship of

production to depositional facies and biozones. Data on cumulative production, cumulative probability, and total production by play have been tabulated and graphed. Oligocene production is predominantly gas with subordinate oil in updip plays (fig. 2).

Oligocene production is restricted to four plays in two regions of the Texas offshore, a southern region consisting of the Mustang and Matagorda Areas and a northern region including the Galveston Area. Both of these regions represent the downdip extension of distal facies that are productive onshore.

One of the key elements of play analysis is to display geologic data for type fields that represent the defining attributes characterizing a given play. Mustang Island Block 889 is an example of a type field characterizing Play 2b, as illustrated by a type log and location and structure-contour maps (fig. 3). Frio–Anahuac Play 2b is a gas play located predominantly in the Mustang Island Area that extends into the Matagorda Island Area. The most distal Frio–Anahuac fields in Play 2b do not extend into Federal OCS. Simple and faulted anticlines comprise the primary trapping mechanism of Play 2b. The depositional style of productive sandstones is characterized by progradational and aggradational distal shoreface and inner shelf sandstones ranging in age from *Marginulina howei* (lower Anahuac) to *Cibicides hazzardi* (upper Frio). Table 1 lists the defining attributes of Play 2b.

**Lower Miocene Plays.** The principal hydrocarbon producing zone in the Texas offshore area is the lower Miocene chronozone; production is primarily gas. Play analysis of lower Miocene reservoirs is almost finished in the Texas offshore area; eleven plays have been defined. In addition, most geologic and engineering data have been compiled and synthesized for lower Miocene fields and reservoirs. Aggregation of data from reservoirs to atlas sand-body reservoirs is ongoing. Type logs have been identified for all fields, and all reservoirs have been located on the type logs. Data on cumulative production, cumulative probability, and total production have been tabulated and graphed for three plays. Integrated play analysis has been finalized in a pilot area extending from Texas State Lands offshore waters into Federal waters from Galveston Area east to Vermilion Area.

One of the initial procedures in play analysis is to locate all reservoirs on field type logs. Strike- and dip-oriented cross sections based on the type logs then become a powerful tool for identifying plays on the basis of lateral and vertical association of productive reservoirs within consistent depositional systems. A cross section linking type logs along the offshore Texas State Lands shows the distribution of lower Miocene plays (fig. 4).

Lower Miocene production is predominantly gas with subordinate oil in updip plays and in association with salt domes. Lower Miocene Play 3b is a gas play in the High Island Area that is typical of the larger lower Miocene gas-prone plays. The depositional style of productive

sandstones is characterized by progradational and aggradational deltaic facies of *Siphonia davisii* sandstones. In High Island 24-L, a type field, most production is from *Siphonia davisii* reservoirs in lower Miocene Play 4b (fig. 5), but substantial production also comes from Plays 4a and 3c. *Siphonia davisii* sandstones form laterally continuous sandbodies that are segmented by normal faulting into a series of fault-block reservoirs (fig. 5). The structural style and primary trapping mechanism are rollover anticlines associated with major extension of the lower Miocene shelf margin. A similar structural style extends down the coastline to the southwest in association with the large, continuous growth faults.

## FUTURE WORK

Future work on task 2—Atlas 1: Miocene and older plays—will concentrate on compiling data needed to classify reservoirs and define plays for Miocene and older reservoirs; such compilation should be completed in calendar 1994.

Preparation of text and figures will continue and should also be completed next year. Cartographic production and editing of text will be initiated in calendar 1994. Task 3—Atlas 2: Plio-Pleistocene plays—will begin in calendar 1994 with data compilation, statistical analysis, and reservoir classification.

## Table 1. Texas State Lands Distal Frio–Anahuac Play 2b

Hydrocarbon Type—Gas prone.

Defining Attribute(s)—Downdip of Play 2a located entirely offshore near the northern margin of the Norias delta system. Growth-faulted rollover anticlines and shale ridges of Greta–Carancahua barrier/strandplain system in lower Anahuac to lower Frio.

Reservoir Facies—Production is from both thin progradational and aggradational distal shoreface and inner shelf sandstones *Marginulina howei* (lower Anahuac) to *Cibicides hazzardi* (upper Frio) in age. Reservoir sandstones are downdip of the Greta–Carancahua barrier/strandplain system and adjacent to the Norias delta system, where a broad sandy shelf interfingers with marine mudstones. Reservoir facies also include thicker sandstones *Marginulina texana* (middle Frio) in age that were probably transported along strike from the Norias delta system and deposited in structurally active basins (Mstg. Isl. Blk. 883–889-S fields).

Structural Style—Simple anticlines, faulted anticlines, growth faults, and shale ridges associated with extension of continental margin.

Trapping Mechanism—Rollover anticlines associated with the downthrown sides of major growth faults and diapiric shale, some production from upthrown side of growth faults and antithetic faults.

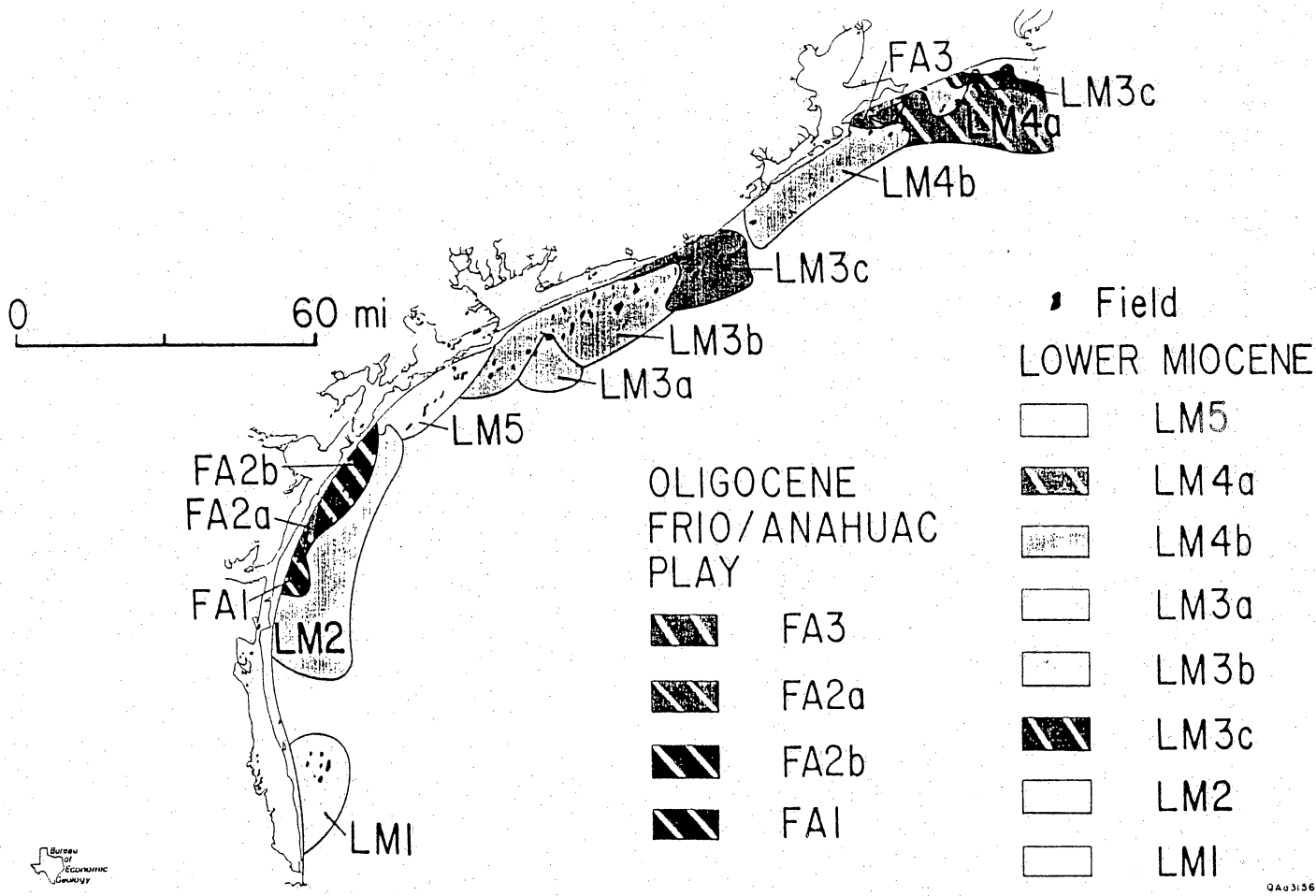
Possible Hydrocarbon Sources—Subjacent shelf and upper slope mudrocks.

Exploration Maturity—Immature to mature.

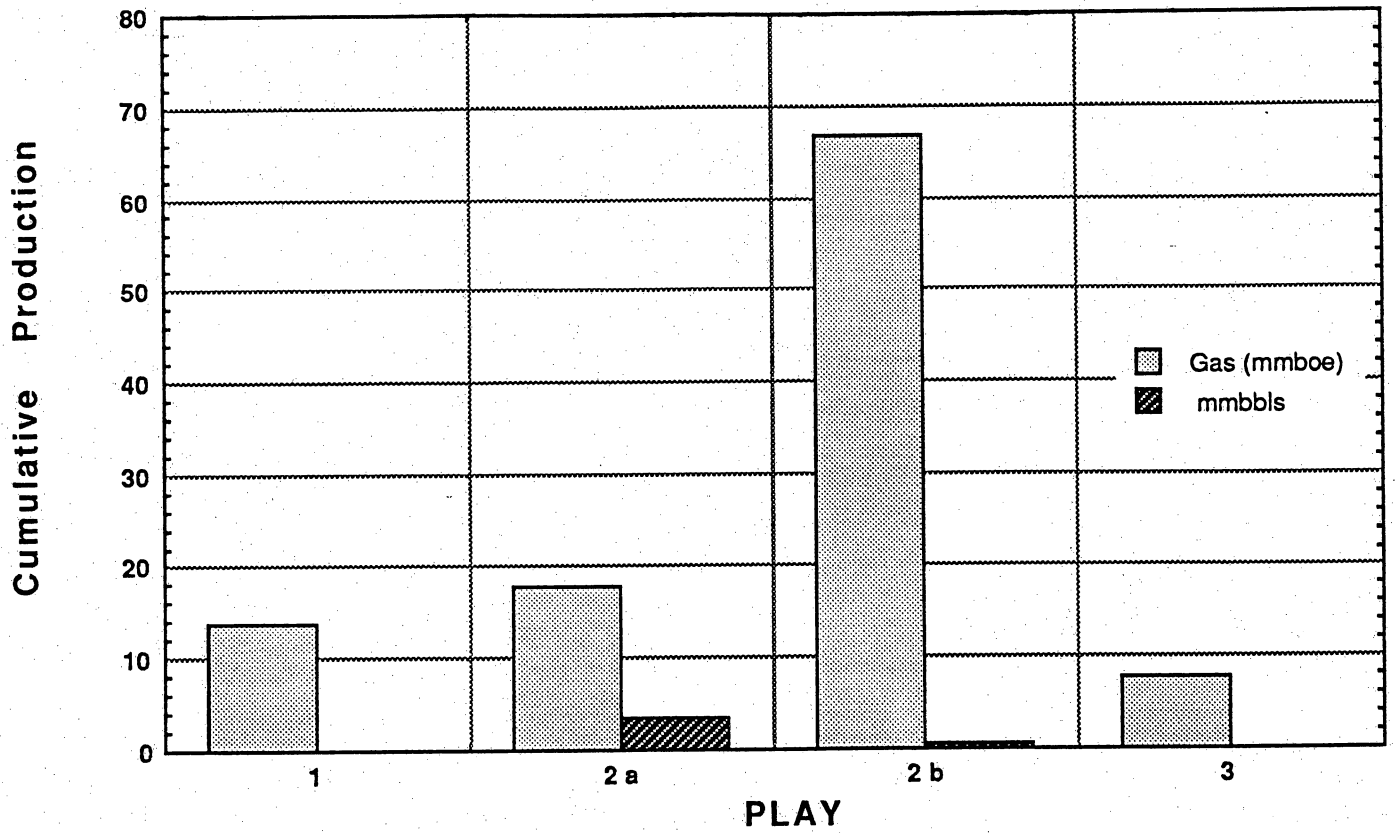
Frontiers—Distal shoreface and barrier/strandplain and slope sandstones in the southern Matagorda Island and Mustang Island offshore areas. Downdip limit of sand is undetermined.

Limitations—Relatively thin reservoir sandstones, porosity and permeability within the play decreases downdip and to the northeast away from the delta source, and gas fields are small.

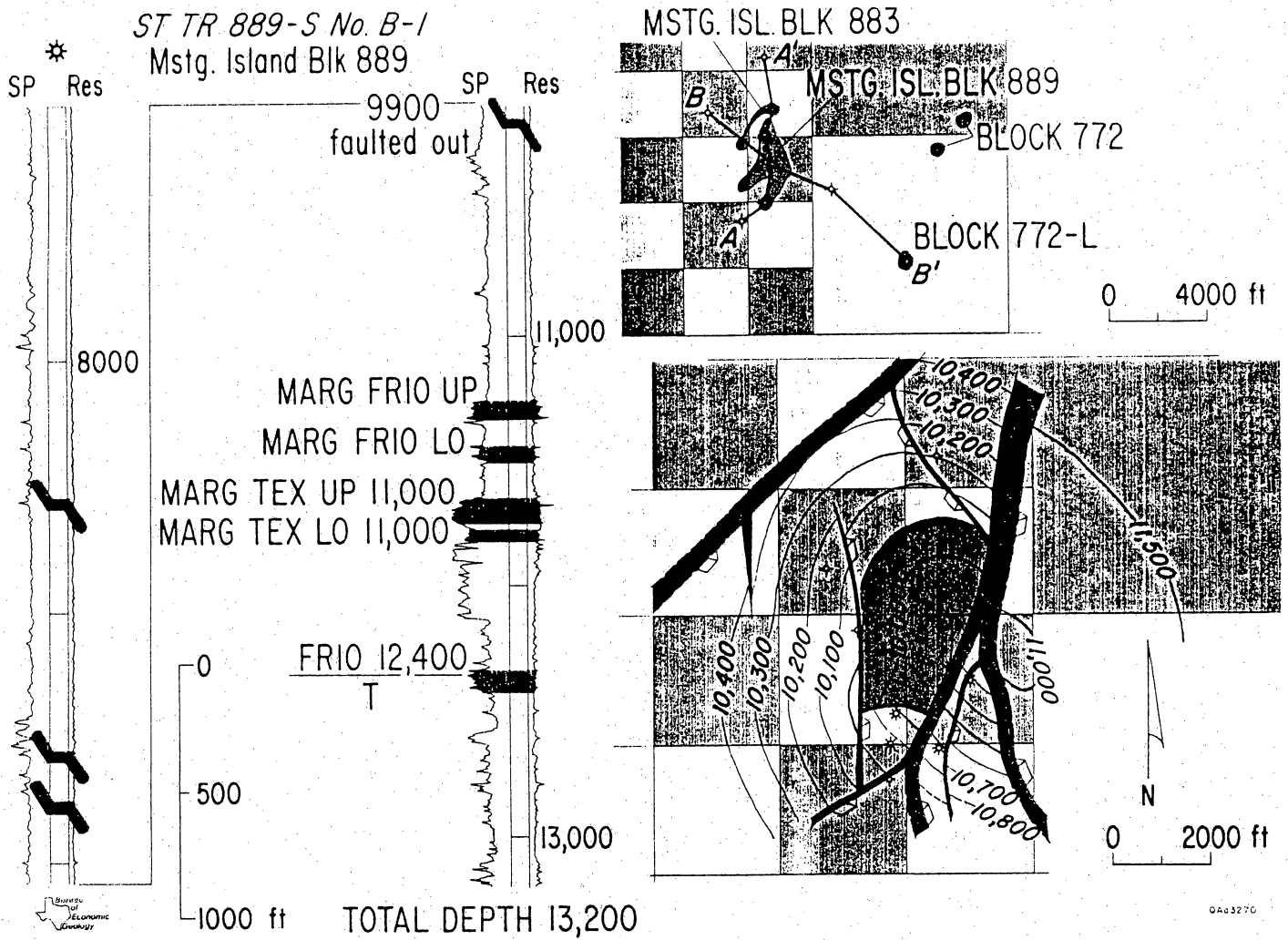




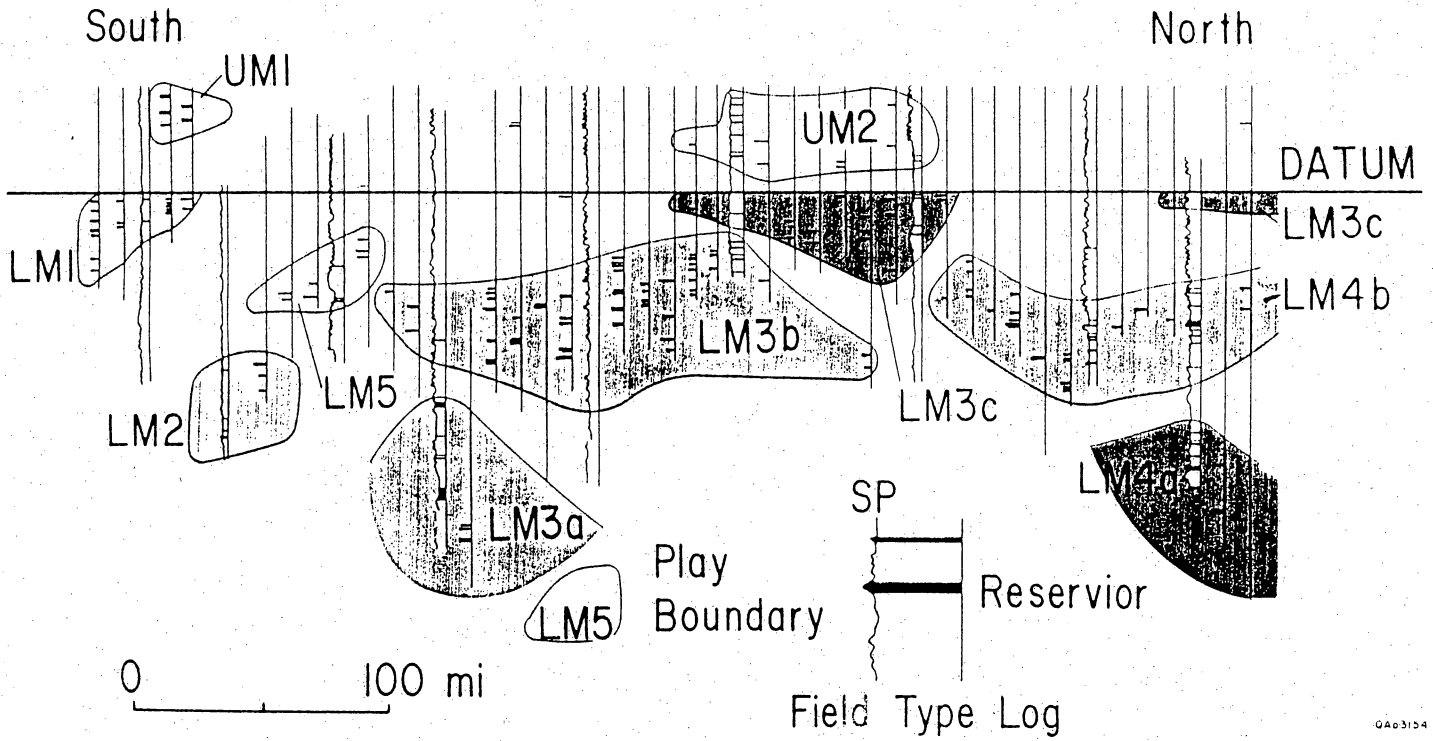
**Figure 1. Map Outlining Distribution of Lower Miocene and Oligocene Plays in Offshore Texas State Lands**



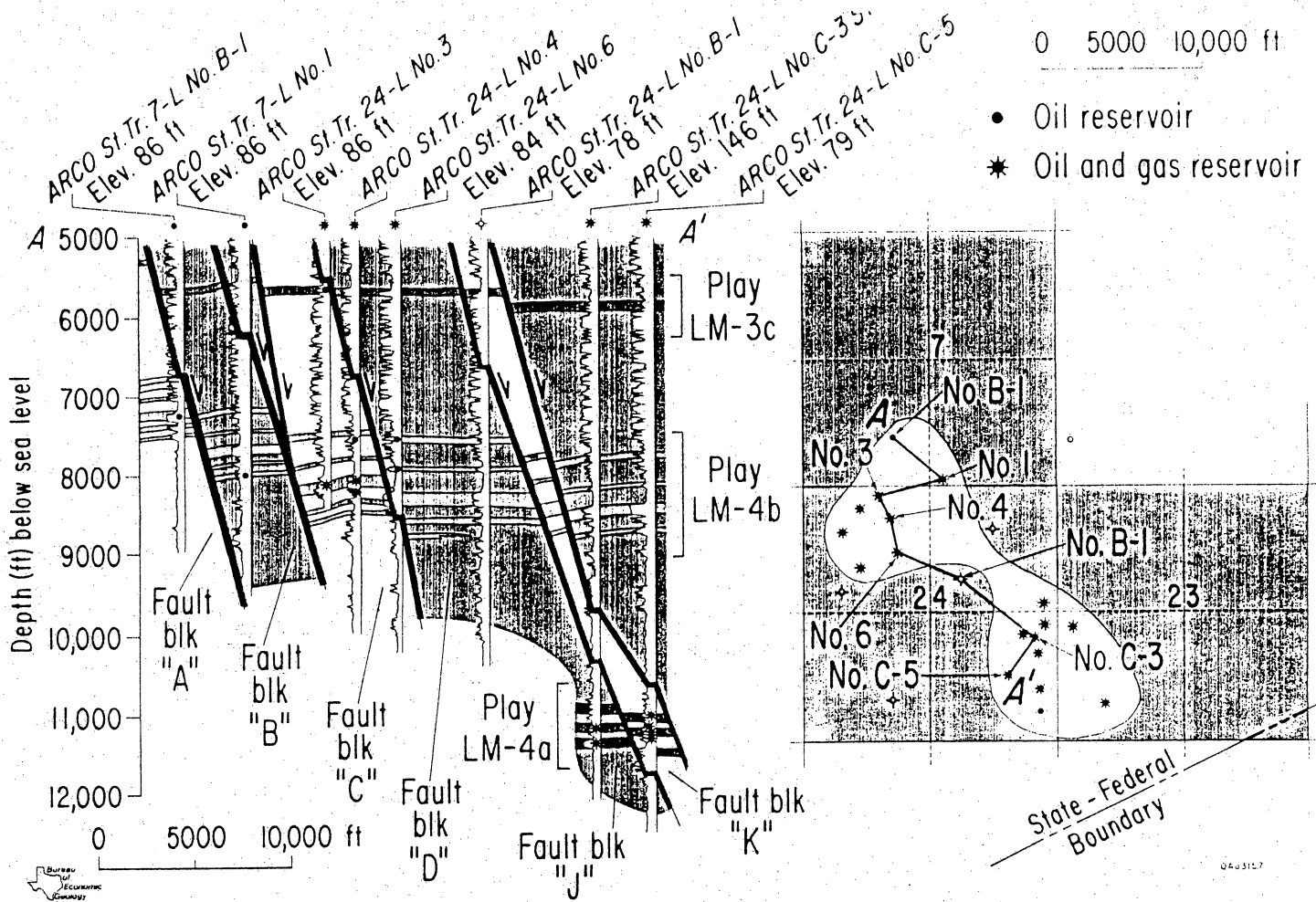
**Figure 2. Histogram Showing Cumulative Production and Hydrocarbon Type for Oligocene Frio-Anahuac Plays**



**Figure 3. Geologic Data from Type Field, Mustang Island Block 889, in Frio-Anahuac Play 2b**



**Figure 4. Cross Section of Type Logs from Fields that Produce from Lower Miocene Reservoirs in Texas State Lands**



**Figure 5. Geologic Data from Type Field, High Island Block 24-L, in Lower Miocene Play 4b**